



Standard Specification for General Requirements for Rolled Structural Steel Bars, Plates, Shapes, and Sheet Piling¹

This standard is issued under the fixed designation A6/A6M; the number immediately following the designation indicates the year of original adoption or, in the case of revision, the year of last revision. A number in parentheses indicates the year of last reapproval. A superscript epsilon (ϵ) indicates an editorial change since the last revision or reapproval.

This standard has been approved for use by agencies of the Department of Defense.

1. Scope*

1.1 This general requirements specification² covers a group of common requirements that, unless otherwise specified in the applicable product specification, apply to rolled structural steel bars, plates, shapes, and sheet piling covered by each of the following product specifications issued by ASTM:

ASTM Designation ³	Title of Specification
A36/A36M	Carbon Structural Steel
A131/A131M	Structural Steel for Ships
A242/A242M	High-Strength Low-Alloy Structural Steel
A283/A283M	Low and Intermediate Tensile Strength Carbon Steel Plates
A328/A328M	Steel Sheet Piling
A514/A514M	High-Yield Strength, Quenched and Tempered Alloy Steel Plate Suitable for Welding
A529/A529M	High-Strength Carbon-Manganese Steel of Structural Quality
A572/A572M	High-Strength Low-Alloy Columbium-Vanadium Steel
A573/A573M	Structural Carbon Steel Plates of Improved Toughness
A588/A588M	High-Strength Low-Alloy Structural Steel with 50 ksi (345 MPa) Minimum Yield Point to 4 in. [100 mm] Thick
A633/A633M	Normalized High-Strength Low-Alloy Structural Steel Plates
A656/A656M	Hot-Rolled Structural Steel, High-Strength Low-Alloy Plate with Improved Formability
A678/A678M	Quenched-and-Tempered Carbon and High-Strength Low-Alloy Structural Steel Plates
A690/A690M	High-Strength Low-Alloy Steel H-Piles and Sheet Piling for Use in Marine Environments
A709/A709M	Carbon and High-Strength Low-Alloy Structural Steel Shapes, Plates, and Bars and Quenched-and-Tempered Alloy Structural Steel Plates for Bridges
A710/A710M	Age-Hardening Low-Carbon Nickel-Copper-Chromium-Molybdenum-Columbium Alloy Structural Steel Plates
A769/A769M	Carbon and High-Strength Electric Resistance Welded Steel Structural Shapes
A786/A786M	Rolled Steel Floor Plates
A808/A808M	High-Strength Low-Alloy Carbon, Manganese, Columbium, Vanadium Steel of Structural Quality with Improved Notch Toughness

A827/A827M	Plates, Carbon Steel, for Forging and Similar Applications
A829/A829M	Plates, Alloy Steel, Structural Quality
A830/A830M	Plates, Carbon Steel, Structural Quality, Furnished to Chemical Composition Requirements
A852/A852M	Quenched and Tempered Low-Alloy Structural Steel Plate with 70 ksi [485 Mpa] Minimum Yield Strength to 4 in. [100 mm] Thick
A857/A857M	Steel Sheet Piling, Cold Formed, Light Gage
A871/A871M	High-Strength Low Alloy Structural Steel Plate with Atmospheric Corrosion Resistance
A913/A913M	Specification for High-Strength Low-Alloy Steel Shapes of Structural Quality, Produced by Quenching and Self-Tempering Process (QST)
A945/A945M	Specification for High-Strength Low-Alloy Structural Steel Plate with Low Carbon and Restricted Sulfur for Improved Weldability, Formability, and Toughness
A950/A950M	Specification for Fusion Bonded Epoxy-Coated Structural Steel H-Piles and Sheet Piling
A992/A992M	Specification for Steel for Structural Shapes for Use in Building Framing
A1026	Specification for Alloy Steel Structural Shapes for Use in Building Framing
A1043/A1043M	Specification for Structural Steel with Low Yield to Tensile Ratio for Use in Buildings

1.2 **Annex A1** lists permitted variations in dimensions and mass (**Note 1**) in SI units. The values listed are not exact conversions of the values in Tables 1 to 31 inclusive but are, instead, rounded or rationalized values. Conformance to **Annex A1** is mandatory when the “M” specification designation is used.

NOTE 1—The term “weight” is used when inch-pound units are the standard; however, under SI, the preferred term is “mass.”

1.3 **Annex A2** lists the dimensions of some shape profiles.

1.4 **Appendix X1** provides information on coil as a source of structural products.

1.5 **Appendix X2** provides information on the variability of tensile properties in plates and structural shapes.

1.6 **Appendix X3** provides information on weldability.

1.7 **Appendix X4** provides information on cold bending of plates, including suggested minimum inside radii for cold bending.

1.8 This general requirements specification also covers a group of supplementary requirements that are applicable to several of the above product specifications as indicated therein.

¹ This specification is under the jurisdiction of ASTM Committee A01 on Steel, Stainless Steel and Related Alloys and is the direct responsibility of Subcommittee A01.02 on Structural Steel for Bridges, Buildings, Rolling Stock and Ships.

Current edition approved Oct. 1, 2010. Published October 2010. Originally approved in 1949. Last previous edition approved in 2010 as A6/A6M – 10. DOI: 10.1520/A0006_A0006M-10A.

² For ASME Boiler and Pressure Vessel Code applications, see related Specification SA-6/SA-6M in Section II of that Code.

*A Summary of Changes section appears at the end of this standard.

Such requirements are provided for use where additional testing or additional restrictions are required by the purchaser, and apply only where specified individually in the purchase order.

1.9 In case of any conflict in requirements, the requirements of the applicable product specification prevail over those of this general requirements specification.

1.10 Additional requirements that are specified in the purchase order and accepted by the supplier are permitted, provided that such requirements do not negate any of the requirements of this general requirements specification or the applicable product specification.

1.11 For purposes of determining conformance with this general requirements specification and the applicable product specification, values are to be rounded to the nearest unit in the right-hand place of figures used in expressing the limiting values in accordance with the rounding method of Practice E29.

1.12 The text of this general requirements specification contains notes or footnotes, or both, that provide explanatory material. Such notes and footnotes, excluding those in tables and figures, do not contain any mandatory requirements.

1.13 The values stated in either inch-pound units or SI units are to be regarded separately as standard. Within the text, the SI units are shown in brackets. The values stated in each system are not exact equivalents; therefore, each system is to be used independently of the other, without combining values in any way.

1.14 This general requirements specification and the applicable product specification are expressed in both inch-pound units and SI units; however, unless the order specifies the applicable “M” specification designation (SI units), the structural product is furnished to inch-pound units.

1.15 *This standard does not purport to address all of the safety concerns, if any, associated with its use. It is the responsibility of the user of this standard to establish appropriate safety and health practices and determine the applicability of regulatory limitations prior to use.*

2. Referenced Documents

2.1 ASTM Standards:³

- A131/A131M Specification for Structural Steel for Ships
- A370 Test Methods and Definitions for Mechanical Testing of Steel Products
- A673/A673M Specification for Sampling Procedure for Impact Testing of Structural Steel
- A700 Practices for Packaging, Marking, and Loading Methods for Steel Products for Shipment
- A751 Test Methods, Practices, and Terminology for Chemical Analysis of Steel Products
- A829/A829M Specification for Alloy Structural Steel Plates
- A941 Terminology Relating to Steel, Stainless Steel, Related Alloys, and Ferroalloys

³ For referenced ASTM standards, visit the ASTM website, www.astm.org, or contact ASTM Customer Service at service@astm.org. For *Annual Book of ASTM Standards* volume information, refer to the standard’s Document Summary page on the ASTM website.

E29 Practice for Using Significant Digits in Test Data to Determine Conformance with Specifications

E112 Test Methods for Determining Average Grain Size

E208 Test Method for Conducting Drop-Weight Test to Determine Nil-Ductility Transition Temperature of Ferritic Steels

2.2 American Welding Society Standards:⁴

- A5.1/A5.1M Mild Steel Covered Arc-Welding Electrodes
 - A5.5/A5.5M Low-Alloy Steel Covered Arc-Welding Electrodes
 - A5.17/A5.17M Specification For Carbon Steel Electrodes And Fluxes For Submerged Arc Welding
 - A5.18/A5.18M Specification For Carbon Steel Electrodes And Rods For Gas Shielded Arc Welding
 - A5.20/A5.20M Carbon Steel Electrodes For Flux Cored Arc Welding
 - A5.23/A5.23M Low Alloy Steel Electrodes And Fluxes For Submerged Arc Welding
 - A5.28/A5.28M Specification For Low-Alloy Steel Electrodes And Rods For Gas Shielded Arc Welding
 - A5.29/A5.29M Specification for Low-Alloy Steel Electrodes for Flux Cored Arc Welding
 - D1.1/D1.1M Structural Welding Code Steel
- ### 2.3 U.S. Military Standards:⁵
- MIL-STD-129 Marking for Shipment and Storage
 - MIL-STD-163 Steel Mill Products Preparation for Shipment and Storage
- ### 2.4 U.S. Federal Standard:⁵
- Fed. Std. No. 123 Marking for Shipments (Civil Agencies)
- ### 2.5 ASME Boiler Pressure Vessel Code Standard:⁶
- BPVC Section IX Welding and Brazing Qualifications

3. Terminology

3.1 Definitions of Terms Specific to This Standard:

3.1.1 *Plates (other than floor plates)*—Flat, hot-rolled steel, ordered to thickness or weight [mass] and typically width and length, commonly classified as follows:

3.1.1.1 When Ordered to Thickness:

(1) Over 8 in. [200 mm] in width and 0.230 in. [6 mm] or over in thickness.

(2) Over 48 in. [1200 mm] in width and 0.180 in. [4.5 mm] or over in thickness.

3.1.1.2 When Ordered to Weight [Mass]:

(1) Over 8 in. [200 mm] in width and 9.392 lb/ft² [47.10 kg/m²] or heavier.

(2) Over 48 in. [1200 mm] in width and 7.350 lb/ft² [35.32 kg/m²] or heavier.

3.1.1.3 *Discussion*—Steel products are available in various thickness, width, and length combinations depending upon equipment and processing capabilities of various manufacturers and processors. Historic limitations of a product based upon

⁴ Available from American Welding Society (AWS), 550 NW LeJeune Rd., Miami, FL 33126, <http://www.aws.org>.

⁵ Available from Standardization Documents Order Desk, DODSSP, Bldg. 4, Section D, 700 Robbins Ave., Philadelphia, PA 19111-5098, <http://www.dodssp.daps.mil>.

⁶ Available from American Society of Mechanical Engineers (ASME), ASME International Headquarters, Three Park Ave., New York, NY 10016-5990, <http://www.asme.org>.

dimensions (thickness, width, and length) do not take into account current production and processing capabilities. To qualify any product to a particular product specification requires all appropriate and necessary tests be performed and that the results meet the limits prescribed in that product specification. If the necessary tests required by a product specification cannot be conducted, the product cannot be qualified to that specification. This general requirement standard contains permitted variations for the commonly available sizes. Permitted variations for other sizes are subject to agreement between the customer and the manufacturer or processor, whichever is applicable.

3.1.1.4 Slabs, sheet bars, and skelp, though frequently falling in the foregoing size ranges, are not classed as plates.

3.1.1.5 Coils are excluded from qualification to the applicable product specification until they are decoiled, leveled or straightened, formed (if applicable), cut to length, and, if required, properly tested by the processor in accordance with ASTM specification requirements (see Sections 9-15, 18, and 19 and the applicable product specification).

3.1.2 Shapes (Flanged Sections):

3.1.2.1 *structural-size shapes*—rolled flanged sections having at least one dimension of the cross section 3 in. [75 mm] or greater.

3.1.2.2 *bar-size shapes*—rolled flanged sections having a maximum dimension of the cross section less than 3 in. [75 mm].

3.1.2.3 “W” shapes—doubly-symmetric, wide-flange shapes with inside flange surfaces that are substantially parallel.

3.1.2.4 “HP” shapes—are wide-flange shapes generally used as bearing piles whose flanges and webs are of the same nominal thickness and whose depth and width are essentially the same.

3.1.2.5 “S” shapes—doubly-symmetric beam shapes with inside flange surfaces that have a slope of approximately 16 $\frac{2}{3}$ %.

3.1.2.6 “M” shapes—doubly-symmetric shapes that cannot be classified as “W,” “S,” or “HP” shapes.

3.1.2.7 “C” shapes—channels with inside flange surfaces that have a slope of approximately 16 $\frac{2}{3}$ %.

3.1.2.8 “MC” shapes—channels that cannot be classified as “C” shapes.

3.1.2.9 “L” shapes—shapes having equal-leg and unequal-leg angles.

3.1.3 *sheet piling*—rolled steel sections that are capable of being interlocked, forming a continuous wall when individual pieces are driven side by side.

3.1.4 *bars*—rounds, squares, and hexagons, of all sizes; flats 1 $\frac{3}{64}$ in. (0.203 in.) and over [over 5 mm] in specified thickness, not over 6 in. [150 mm] in specified width; and flats 0.230 in. and over [over 6 mm] in specified thickness, over 6 to 8 in. [150 to 200 mm] inclusive, in specified width.

3.1.5 *exclusive*—when used in relation to ranges, as for ranges of thickness in the tables of permissible variations in dimensions, is intended to exclude only the greater value of the

range. Thus, a range from 60 to 72 in. [1500 to 1800 mm] exclusive includes 60 in. [1500 mm], but does not include 72 in. [1800 mm].

3.1.6 *rimmed steel*—steel containing sufficient oxygen to give a continuous evolution of carbon monoxide during solidification, resulting in a case or rim of metal virtually free of voids.

3.1.7 *semi-killed steel*—incompletely deoxidized steel containing sufficient oxygen to form enough carbon monoxide during solidification to offset solidification shrinkage.

3.1.8 *capped steel*—rimmed steel in which the rimming action is limited by an early capping operation. Capping is carried out mechanically by using a heavy metal cap on a bottle-top mold or chemically by an addition of aluminum or ferrosilicon to the top of the molten steel in an open-top mold.

3.1.9 *killed steel*—steel deoxidized, either by addition of strong deoxidizing agents or by vacuum treatment, to reduce the oxygen content to such a level that no reaction occurs between carbon and oxygen during solidification.

3.1.10 *mill edge*—the normal edge produced by rolling between horizontal finishing rolls. A mill edge does not conform to any definite contour. Mill edge plates have two mill edges and two trimmed edges.

3.1.11 *universal mill edge*—the normal edge produced by rolling between horizontal and vertical finishing rolls. Universal mill plates, sometimes designated UM Plates, have two universal mill edges and two trimmed edges.

3.1.12 *sheared edge*—the normal edge produced by shearing. Sheared edge plates are trimmed on all edges.

3.1.13 *gas cut edge*—the edge produced by gas flame cutting.

3.1.14 *special cut edge*—usually the edge produced by gas flame cutting involving special practices such as pre-heating or post-heating, or both, in order to minimize stresses, avoid thermal cracking and reduce the hardness of the gas cut edge. In special instances, special cut edge is used to designate an edge produced by machining.

3.1.15 *sketch*—when used to describe a form of plate, denotes a plate other than rectangular, circular, or semi-circular. Sketch plates may be furnished to a radius or with four or more straight sides.

3.1.16 *normalizing*—a heat treating process in which a steel plate is reheated to a uniform temperature above the upper critical temperature and then cooled in air to below the transformation range.

3.1.17 *plate-as-rolled*—when used in relation to the location and number of tests, the term refers to the unit plate rolled from a slab or directly from an ingot. It does not refer to the condition of the plate.

3.1.18 *fine grain practice*—a steelmaking practice that is intended to produce a killed steel that is capable of meeting the requirements for fine austenitic grain size.

3.1.18.1 *Discussion*—It normally involves the addition of one or more austenitic grain refining elements in amounts that have been established by the steel producer as being sufficient. Austenitic grain refining elements include, but are not limited to, aluminum, columbium, titanium, and vanadium.

3.1.19 *structural product*—a hot-rolled steel plate, shape, sheet piling, or bar.

3.1.20 *coil*—hot-rolled steel in coiled form that is intended to be processed into a finished structural product.

3.1.21 *manufacturer*—the organization that directly controls the conversion of steel ingots, slabs, blooms, or billets, by hot-rolling, into an as-rolled structural product or into coil; and for structural products produced from as-rolled structural products, the organization that directly controls, or is responsible for, the operations involved in finishing the structural product.

3.1.21.1 *Discussion*—Such finishing operations include leveling or straightening, hot forming or cold forming (if applicable), welding (if applicable), cutting to length, testing, inspection, conditioning, heat treatment (if applicable), packaging, marking, loading for shipment, and certification.

3.1.22 *processor*—the organization that directly controls, or is responsible for, the operations involved in the processing of coil into a finished structural product. Such processing operations include decoiling, leveling or straightening, hot-forming or cold-forming (if applicable), welding (if applicable), cutting to length, testing, inspection, conditioning, heat treatment (if applicable), packaging, marking, loading for shipment, and certification.

3.1.22.1 *Discussion*—The processing operations need not be done by the organization that did the hot rolling of the coil. If only one organization is involved in the hot rolling and processing operations, that organization is termed the *manufacturer* for the hot rolling operation and the *processor* for the processing operations. If more than one organization is involved in the hot rolling and processing operations, the organization that did the hot rolling is termed the *manufacturer* and an organization that does one or more processing operations is termed a *processor*.

3.2 Refer to Terminology [A941](#) for additional definitions of terms used in this standard.

4. Ordering Information

4.1 Information items to be considered, if appropriate, for inclusion in purchase orders are as follows:

4.1.1 ASTM product specification designation (see [1.1](#)) and year-date;

4.1.2 Name of structural product (plate, shape, bar, or sheet piling);

4.1.3 Shape designation, or size and thickness or diameter;

4.1.4 Grade, class, and type designation, if applicable;

4.1.5 Condition (see Section [6](#)), if other than as-rolled;

4.1.6 Quantity (weight [mass] or number of pieces);

4.1.7 Length;

4.1.8 Exclusion of either structural product produced from coil or structural product produced from an as-rolled structural product (see [5.3](#) and [Appendix X1](#)), if applicable;

4.1.9 Heat treatment requirements (see [6.2](#) and [6.3](#)), if any;

4.1.10 Testing for fine austenitic grain size (see [8.3.2](#));

4.1.11 Mechanical property test report requirements (see Section [14](#)), if any;

4.1.12 Special packaging, marking, and loading for shipment requirements (see Section [19](#)), if any;

4.1.13 Supplementary requirements, if any, including any additional requirements called for in the supplementary requirements;

4.1.14 End use, if there are any end-use-specific requirements (see [18.1](#), [11.3.4](#), Table 22 or Table A1.22, and Table 24 or Table A1.24);

4.1.15 Special requirements (see [1.10](#)), if any; and

4.1.16 Repair welding requirements (see [9.5](#)), if any.

5. Materials and Manufacture

5.1 The steel shall be made in an open-hearth, basic-oxygen, or electric-arc furnace, possibly followed by additional refining in a ladle metallurgy furnace (LMF), or secondary melting by vacuum-arc remelting (VAR) or electroslag remelting (ESR).

5.2 The steel shall be strand cast or cast in stationary molds.

5.2.1 *Strand Cast*:

5.2.1.1 When heats of the same nominal chemical composition are consecutively strand cast at one time, the heat number assigned to the cast product need not be changed until all of the steel in the cast product is from the following heat.

5.2.1.2 When two consecutively strand cast heats have different nominal chemical composition ranges, the manufacturer shall remove the transition material by an established procedure that positively separates the grades.

5.3 Structural products shall be produced from an as-rolled structural product or from coil.

5.4 Where part of a heat is rolled into an as-rolled structural product and the balance of the heat is rolled into coil, each part shall be tested separately.

5.5 Structural products produced from coil shall not contain splice welds, unless previously approved by the purchaser.

6. Heat Treatment

6.1 Where the structural product is required to be heat treated, such heat treatment shall be performed by the manufacturer, the processor, or the fabricator, unless otherwise specified in the applicable product specification.

NOTE 2—When no heat treatment is required, the manufacturer or processor has the option of heat treating the structural product by normalizing, stress relieving, or normalizing then stress relieving to meet the applicable product specification.

6.2 Where the heat treatment is to be performed by other than the manufacturer, the order shall so state.

6.2.1 Where the heat treatment is to be performed by other than the manufacturer, the structural products shall be accepted on the basis of tests made on test specimens taken from full thickness test coupons heat treated in accordance with the requirements specified in the applicable product specification or in the purchase order. If the heat-treatment temperatures are not specified, the manufacturer or processor shall heat treat the test coupons under conditions he considers appropriate, provided that the purchaser is informed of the procedure followed in heat treating the test coupons.

6.3 Where the heat treatment is to be performed by the manufacturer or the processor, the structural product shall be heat treated as specified in the applicable product specification, or as specified in the purchase order, provided that the heat treatment specified by the purchaser is not in conflict with the requirements of the applicable product specification.

6.4 Where normalizing is to be performed by the fabricator, the structural product shall be either normalized or heated uniformly for hot forming, provided that the temperature to which the structural product is heated for hot forming does not significantly exceed the normalizing temperature.

6.5 The use of cooling rates that are faster than those obtained by cooling in air to improve the toughness shall be subject to approval by the purchaser, and structural products so treated shall be tempered subsequently in the range from 1100 to 1300°F [595 to 705°C].

7. Chemical Analysis

7.1 Heat Analysis:

7.1.1 Sampling for chemical analysis and methods of analysis shall be in accordance with Test Methods, Practices, and Terminology **A751**.

7.1.2 For each heat, the heat analysis shall include determination of the content of carbon, manganese, phosphorus, sulfur, silicon, nickel, chromium, molybdenum, copper, vanadium, columbium; any other element that is specified or restricted by the applicable product specification for the applicable grade, class, and type; and any austenitic grain refining element whose content is to be used in place of austenitic grain size testing of the heat (see **8.3.2**).

7.1.3 Except as allowed by **7.1.4** for primary heats, heat analyses shall conform to the heat analysis requirements of the applicable product specification for the applicable grade, class, and type.

7.1.4 Where vacuum-arc remelting or electroslag remelting is used, a remelted heat is defined as all ingots remelted from a single primary heat. If the heat analysis of the primary heat conforms to the heat analysis requirements of the applicable product specification for the applicable grade, class, and type, the heat analysis for the remelted heat shall be determined from one test sample taken from one remelted ingot, or the product of one remelted ingot, from the primary heat. If the heat analysis of the primary heat does not conform to the heat analysis requirements of the applicable product specification for the applicable grade, type, and class, the heat analysis for the remelted heat shall be determined from one test sample taken from each remelted ingot, or the product of each remelted ingot, from the primary heat.

7.2 *Product Analysis*—For each heat, the purchaser shall have the option of analyzing representative samples taken from the finished structural product. Sampling for chemical analysis and methods of analysis shall be in accordance with Test Methods, Practices, and Terminology **A751**. The product analyses so determined shall conform to the heat analysis requirements of the applicable product specification for the applicable grade, class, and type, subject to the permitted variations in product analysis given in Table A. If a range is specified, the determinations of any element in a heat shall not vary both above and below the specified range. Rimmed or capped steel is characterized by a lack of homogeneity in its composition, especially for the elements carbon, phosphorus, and sulfur. Therefore, the limitations for these elements shall not be applicable unless misapplication is clearly indicated.

7.3 *Referee Analysis*—For referee purposes, Test Methods, Practices, and Terminology **A751** shall be used.

7.4 *Grade Substitution*—Alloy steel grades that meet the chemical requirements of Table 1 of Specification **A829/A829M** shall not be substituted for carbon steel grades.

8. Metallurgical Structure

8.1 Where austenitic grain size testing is required, such testing shall be in accordance with Test Methods **E112** and at least 70 % of the grains in the area examined shall meet the specified grain size requirement.

8.2 *Coarse Austenitic Grain Size*—Where coarse austenitic grain size is specified, one austenitic grain size test per heat shall be made and the austenitic grain size number so determined shall be in the range of 1 to 5 inclusive.

8.3 Fine Austenitic Grain Size:

8.3.1 Where fine austenitic grain size is specified, except as allowed in **8.3.2**, one austenitic grain size test per heat shall be made and the austenitic grain size number so determined shall be 5 or higher.

NOTE 3—Such austenitic grain size numbers may be achieved with lower contents of austenitic grain refining elements than **8.3.2** requires for austenitic grain size testing to be waived.

8.3.2 Unless testing for fine austenitic grain size is specified in the purchase order, an austenitic grain size test need not be made for any heat that has, by heat analysis, one or more of the following:

8.3.2.1 A total aluminum content of 0.020 % or more.

8.3.2.2 An acid soluble aluminum content of 0.015 % or more.

8.3.2.3 A content for an austenitic grain refining element that exceeds the minimum value agreed to by the purchaser as being sufficient for austenitic grain size testing to be waived, or

8.3.2.4 Contents for the combination of two or more austenitic grain refining elements that exceed the applicable minimum values agreed to by the purchaser as being sufficient for austenitic grain size testing to be waived.

9. Quality

9.1 *General*—Structural products shall be free of injurious defects and shall have a workmanlike finish.

NOTE 4—Unless otherwise specified, structural products are normally furnished in the as-rolled condition and are subjected to visual inspection by the manufacturer or processor. Non-injurious surface or internal imperfections, or both, may be present in the structural product as delivered and the structural product may require conditioning by the purchaser to improve its appearance or in preparation for welding, coating, or other further operations.

More restrictive requirements may be specified by invoking supplementary requirements or by agreement between the purchaser and the supplier.

Structural products that exhibit injurious defects during subsequent fabrication are deemed not to comply with the applicable product specification. (See **17.2**.) Fabricators should be aware that cracks may initiate upon bending a sheared or burned edge during the fabrication process; this is not considered to be a fault of the steel but is rather a function of the induced cold-work or the heat-affected zone.

The conditioning requirements in **9.2**, **9.3**, and **9.4** limit the conditioning allowed to be performed by the manufacturer or processor. Conditioning of imperfections beyond the limits of **9.2**, **9.3**, and **9.4** may be performed by parties other than the manufacturer or processor at the discretion of the purchaser.

TABLE A Permitted Variations in Product Analysis

NOTE 1—Where “...” appears in this table, there is no requirement.

Element	Upper Limit, or Maximum Specified Value, %	Permitted Variations, %	
		Under	Over
		Minimum Limit	Maximum Limit
Carbon	to 0.15 incl	0.02	0.03
	over 0.15 to 0.40 incl	0.03	0.04
	over 0.40 to 0.75 incl	0.04	0.05
	over 0.75	0.04	0.06
Manganese ^A	to 0.60 incl	0.05	0.06
	over 0.60 to 0.90 incl	0.06	0.08
	over 0.90 to 1.20 incl	0.08	0.10
	over 1.20 to 1.35 incl	0.09	0.11
	over 1.35 to 1.65 incl	0.09	0.12
	over 1.65 to 1.95 incl	0.11	0.14
Phosphorus	to 0.04 incl	...	0.010
	over 0.04 to 0.15 incl	...	^B
Sulfur	to 0.06 incl	...	0.010
	over 0.06	^B	^B
Silicon	to 0.30 incl	0.02	0.03
	over 0.30 to 0.40 incl	0.05	0.05
	over 0.40 to 2.20 incl	0.06	0.06
Nickel	to 1.00 incl	0.03	0.03
	over 1.00 to 2.00 incl	0.05	0.05
	over 2.00 to 3.75 incl	0.07	0.07
	over 3.75 to 5.30 incl	0.08	0.08
	over 5.30	0.10	0.10
Chromium	to 0.90 incl	0.04	0.04
	over 0.90 to 2.00 incl	0.06	0.06
	over 2.00 to 4.00 incl	0.10	0.10
Molybdenum	to 0.20 incl	0.01	0.01
	over 0.20 to 0.40 incl	0.03	0.03
	over 0.40 to 1.15 incl	0.04	0.04
Copper	0.20 minimum only	0.02	...
	to 1.00 incl	0.03	0.03
	over 1.00 to 2.00 incl	0.05	0.05
Titanium	to 0.15 incl	0.01 ^C	0.01
Vanadium	to 0.10 incl	0.01 ^C	0.01
	over 0.10 to 0.25 incl	0.02	0.02
	over 0.25	0.02	0.03
	minimum only specified	0.01	...
Boron	any	^B	^B
Columbium	to 0.10 incl	0.01 ^C	0.01
Zirconium	to 0.15 incl	0.03	0.03
Nitrogen	to 0.030 incl	0.005	0.005

^A Permitted variations in manganese content for bars and bar size shapes shall be: to 0.90 incl ± 0.03 ; over 0.90 to 2.20 incl ± 0.06 .

^B Product analysis not applicable.

^C 0.005, if the minimum of the range is 0.01 %.

Index to Tables of Permitted Variations

Dimension	Table	
	Inch-Pound Units	SI Units
Camber		
Plates, Carbon Steel; Sheared and Gas-Cut	12	A1.12
Plates, Carbon Steel; Universal Mill	11	A1.11
Plates, Other than Carbon Steel; Sheared, Gas-Cut and Universal Mill	11	A1.11
Shapes, Rolled; S, M, C, MC, and L	21	A1.21
Shapes, Rolled; W and HP	24	A1.24
Shapes, Split; L and T	25	A1.25
Cross Section of Shapes and Bars		
Flats	26	A1.26
Hexagons	28	A1.28
Rounds and Squares	27	A1.27
Shapes, Rolled; L, Bulb Angles, and Z	17	A1.17
Shapes, Rolled; W, HP, S, M, C, and MC	16	A1.16
Shapes, Rolled; T	18	A1.18
Shapes, Split; L and T	25	A1.25
Diameter		
Plates, Sheared	6	A1.6
Plates, Other than Alloy Steel, Gas-Cut	7	A1.7
Plates, Alloy Steel, Gas-Cut	10	A1.10
Rounds	27	A1.27
End Out-of-Square		
Shapes, Other than W	20	A1.20
Shapes, W	22	A1.22
Shapes, Milled, Other than W	23	A1.23
Flatness		
Plates, Carbon Steel	13	A1.13
Plates, Other than Carbon Steel	14	A1.14
Plates, Restrictive—Carbon Steel	S27.1	S27.2
Plates, Restrictive—Other than Carbon Steel	S27.3	S27.4
Length		
Bars	30	A1.30
Bars, Recut	31	A1.31
Plates, Sheared and Universal Mill	3	A1.3
Plates, Other than Alloy Steel, Gas-Cut	9	A1.9
Plates, Alloy Steel, Gas-Cut	8	A1.8
Plates, Mill Edge	4	A1.4
Shapes, Rolled; Other than W	19	A1.19
Shapes, Rolled; W and HP	22	A1.22
Shapes, Split; L and T	25	A1.25
Shapes, Milled	23	A1.23
Straightness		
Bars	29	A1.29
Shapes, Other than W	21	A1.21
Sweep		
Shapes, W and HP	24	A1.24
Thickness		
Flats	26	A1.26
Plates, Ordered to Thickness	1	A1.1
Waviness		
Plates	15	A1.15
Weight [Mass]		
Plates, Ordered to Weight [Mass]	2	A1.2
Width		
Flats	26	A1.26
Plates, Sheared	3	A1.3
Plates, Universal Mill	5	A1.5
Plates, Other than Alloy Steel, Gas-Cut	9	A1.9
Plates, Alloy Steel, Gas-Cut	8	A1.8
Plates, Mill Edge	4	A1.4

9.2 Plate Conditioning:

9.2.1 The grinding of plates by the manufacturer or processor to remove imperfections on the top or bottom surface shall be subject to the limitations that the area ground is well faired without abrupt changes in contour and the grinding does not reduce the thickness of the plate by (1) more than 7 % under the nominal thickness for plates ordered to weight per square foot or mass per square metre, but in no case more than 1/8 in. [3 mm]; or (2) below the permissible minimum thickness for plates ordered to thickness in inches or millimetres.

9.2.2 The deposition of weld metal (see 9.5) following the removal of imperfections on the top or bottom surface of plates by chipping, grinding, or arc-air gouging shall be subject to the following limiting conditions:

9.2.2.1 The chipped, ground, or gouged area shall not exceed 2 % of the area of the surface being conditioned.

9.2.2.2 After removal of any imperfections preparatory to welding, the thickness of the plate at any location shall not be reduced by more than 30 % of the nominal thickness of the plate. (Specification A131/A131M restricts the reduction in thickness to 20 % maximum.)

9.2.3 The deposition of weld metal (see 9.5) following the removal of injurious imperfections on the edges of plates by grinding, chipping, or arc-air gouging by the manufacturer or processor shall be subject to the limitation that, prior to welding, the depth of the depression, measured from the plate edge inward, is not more than the thickness of the plate or 1 in. [25 mm], whichever is the lesser.

9.3 Structural Size Shapes, Bar Size Shapes, and Sheet Piling Conditioning:

9.3.1 The grinding, or chipping and grinding, of structural size shapes, bar size shapes, and sheet piling by the manufacturer or processor to remove imperfections shall be subject to the limitations that the area ground is well faired without abrupt changes in contour and the depression does not extend below the rolled surface by more than (1) 1/32 in. [1 mm], for material less than 3/8 in. [10 mm] in thickness; (2) 1/16 in. [2 mm], for material 3/8 to 2 in. [10 to 50 mm] inclusive in thickness; or (3) 1/8 in. [3 mm], for material over 2 in. [50 mm] in thickness.

9.3.2 The deposition of weld metal (see 9.5) following removal of imperfections that are greater in depth than the limits listed in 9.3.1 shall be subject to the following limiting conditions:

9.3.2.1 The total area of the chipped or ground surface of any piece prior to welding shall not exceed 2 % of the total surface area of that piece.

9.3.2.2 The reduction of thickness of the material resulting from removal of imperfections prior to welding shall not exceed 30 % of the nominal thickness at the location of the imperfection, nor shall the depth of depression prior to welding exceed 1 1/4 in. [32 mm] in any case except as noted in 9.3.2.3.

9.3.2.3 The deposition of weld metal (see 9.5) following grinding, chipping, or arc-air gouging of the toes of angles, beams, channels, and zees and the stems and toes of tees shall be subject to the limitation that, prior to welding, the depth of the depression, measured from the toe inward, is not more than

the thickness of the material at the base of the depression or 1/2 in. [12.5 mm], whichever is the lesser.

9.3.2.4 The deposition of weld metal (see 9.5) and grinding to correct or build up the interlock of any sheet piling section at any location shall be subject to the limitation that the total surface area of the weld not exceed 2 % of the total surface area of the piece.

9.4 Bar Conditioning:

9.4.1 The conditioning of bars by the manufacturer or processor to remove imperfections by grinding, chipping, or some other means shall be subject to the limitations that the conditioned area is well faired and the affected sectional area is not reduced by more than the applicable permitted variations (see Section 12).

9.4.2 The deposition of weld metal (see 9.5) following chipping or grinding to remove imperfections that are greater in depth than the limits listed in 9.4.1 shall be subject to the following conditions:

9.4.2.1 The total area of the chipped or ground surface of any piece, prior to welding, shall not exceed 2 % of the total surface area of the piece.

9.4.2.2 The reduction of sectional dimension of a round, square, or hexagon bar, or the reduction in thickness of a flat bar, resulting from removal of an imperfection, prior to welding, shall not exceed 5 % of the nominal dimension or thickness at the location of the imperfection.

9.4.2.3 For the edges of flat bars, the depth of the conditioning depression prior to welding shall be measured from the edge inward and shall be limited to a maximum depth equal to the thickness of the flat bar or 1/2 in. [12.5 mm], whichever is less.

9.5 Repair by Welding:

9.5.1 General Requirements:

9.5.1.1 Repair by welding shall be in accordance with a welding procedure specification (WPS) using shielded metal arc welding (SMAW), gas metal arc welding (GMAW), flux cored arc welding (FCAW), or submerged arc welding (SAW) processes. Shielding gases used shall be of welding quality.

9.5.1.2 Electrodes and electrode-flux combinations shall be in accordance with the requirements of AWS Specifications A5.1/A5.1M, A5.5/A5.5M, A5.17/A5.17M, A5.18/A5.18M, A5.20/A5.20M, A5.23/A5.23M, A5.28/A5.28M, or A5.29/A5.29M, whichever is applicable. For SMAW, low hydrogen electrodes shall be used.

9.5.1.3 Electrodes and electrode-flux combinations shall be selected so that the tensile strength of the deposited weld metal (after any required heat treatment) is consistent with the tensile strength specified for the base metal being repaired.

9.5.1.4 Welding electrodes and flux materials shall be dry and protected from moisture during storage and use.

9.5.1.5 Prior to repair welding, the surface to be welded shall be inspected to verify that the imperfections intended to be removed have been removed completely. Surfaces to be welded and surfaces adjacent to the weld shall be dry and free of scale, slag, rust, moisture, grease, and other foreign material that would prevent proper welding.

9.5.1.6 Welders and welding operators shall be qualified in accordance with the requirements of AWS D1.1/D1.1M or

BPVC Section IX, except that any complete joint penetration groove weld qualification also qualifies the welder or welding operator to do repair welding.

9.5.1.7 Repair welding of structural products shall be in accordance with a welding procedure specification (WPS) that is in accordance with the requirements of AWS **D1.1/D1.1M** or **BPVC Section IX**, with the following exceptions or clarifications:

(1) The WPS shall be qualified by testing a complete joint penetration groove weld or a surface groove weld.

(2) The geometry of the surface groove weld need not be described in other than a general way.

(3) An AWS **D1.1/D1.1M** prequalified complete joint penetration groove weld WPS is acceptable.

(4) Any material not listed in the prequalified base metal-filler metal combinations of AWS **D1.1/D1.1M** also is considered to be prequalified if its chemical composition and mechanical properties are comparable to those for one of the prequalified base metals listed in AWS **D1.1/D1.1M**.

(5) Any material not listed in **BPVC Section IX** also is considered to be a material with an S-number in **BPVC Section IX** if its chemical composition and its mechanical properties are comparable to those for one of the materials listed in **BPVC Section IX** with an S-number.

9.5.1.8 When so specified in the purchase order, the WPS shall include qualification by Charpy V-notch testing, with the test locations, test conditions, and the acceptance criteria meeting the requirements specified for repair welding in the purchase order.

9.5.1.9 When so specified in the purchase order, the welding procedure specification shall be subject to approval by the purchaser prior to repair welding.

9.5.2 *Structural Products with a Specified Minimum Tensile Strength of 100 ksi [690 MPa] or Higher*—Repair welding of structural products with a specified minimum tensile strength of 100 ksi [690 MPa] or higher shall be subject to the following additional requirements:

9.5.2.1 When so specified in the purchase order, prior approval for repair by welding shall be obtained from the purchaser.

9.5.2.2 The surface to be welded shall be inspected using a magnetic particle method or a liquid penetrant method to verify that the imperfections intended to be removed have been completely removed. When magnetic particle inspection is employed, the surface shall be inspected both parallel and perpendicular to the length of the area to be repaired.

9.5.2.3 When weld repairs are to be post-weld heat-treated, special care shall be exercised in the selection of electrodes to avoid those compositions that embrittle as a result of such heat treatment.

9.5.2.4 Repairs on structural products that are subsequently heat-treated at the mill shall be inspected after heat treatment; repairs on structural products that are not subsequently heat-treated at the mill shall be inspected no sooner than 48 h after welding. Such inspection shall use a magnetic particle method or a liquid penetrant method; where magnetic particle inspection is involved, such inspection shall be both parallel to and perpendicular to the length of the repair.

9.5.2.5 The location of the weld repairs shall be marked on the finished piece.

9.5.3 *Repair Quality*—The welds and adjacent heat-affected zone shall be sound and free of cracks, the weld metal being thoroughly fused to all surfaces and edges without undercutting or overlap. Any visible cracks, porosity, lack of fusion, or undercut in any layer shall be removed prior to deposition of the succeeding layer. Weld metal shall project at least $\frac{1}{16}$ in. (2 mm) above the rolled surface after welding, and the projecting metal shall be removed by chipping or grinding, or both, to make it flush with the rolled surface, and to produce a workmanlike finish.

9.5.4 *Inspection of Repair*—The manufacturer or processor shall maintain an inspection program to inspect the work to see that:

9.5.4.1 Imperfections have been completely removed.

9.5.4.2 The limitations specified above have not been exceeded.

9.5.4.3 Established welding procedures have been followed, and

9.5.4.4 Any weld deposit is of acceptable quality as defined above.

10. Test Methods

10.1 All tests shall be conducted in accordance with Test Methods and Definitions **A370**.

10.2 Yield strength shall be determined either by the 0.2 % offset method or by the 0.5 % extension under load method, unless otherwise stated in the material specification.

10.3 *Rounding Procedures*—For purposes of determining conformance with the specification, a calculated value shall be rounded to the nearest 1 ksi [5 MPa] tensile and yield strength, and to the nearest unit in the right-hand place of figures used in expressing the limiting value for other values in accordance with the rounding method given in Practice **E29**.

10.4 For full-section test specimens of angles, the cross-sectional area used for calculating the yield and tensile strengths shall be a theoretical area calculated on the basis of the weight of the test specimen (see **12.1**).

11. Tension Tests

11.1 *Condition*—Test specimens for non-heat-treated structural products shall be taken from test coupons that are representative of the structural products in their delivered condition. Test specimens for heat-treated structural products shall be taken from test coupons that are representative of the structural products in their delivered condition, or from separate pieces of full thickness or full section from the same heat similarly heat treated.

11.1.1 Where the plate is heat treated with a cooling rate faster than still-air cooling from the austenitizing temperature, one of the following shall apply in addition to other requirements specified herein:

11.1.1.1 The gage length of the tension test specimen shall be taken at least $1T$ from any as-heat treated edge where T is the thickness of the plate and shall be at least $\frac{1}{2}$ in. [12.5 mm] from flame cut or heat-affected-zone surfaces.

11.1.1.2 A steel thermal buffer pad, $1T$ by $1T$ by at least $3T$, shall be joined to the plate edge by a partial penetration weld completely sealing the buffered edge prior to heat treatment.

11.1.1.3 Thermal insulation or other thermal barriers shall be used during the heat treatment adjacent to the plate edge where specimens are to be removed. It shall be demonstrated that the cooling rate of the tension test specimen is no faster than, and not substantially slower than, that attained by the method described in 11.1.1.2.

11.1.1.4 When test coupons cut from the plate but heat treated separately are used, the coupon dimensions shall be not less than $3T$ by $3T$ by T and each tension specimen cut from it shall meet the requirements of 11.1.1.1.

11.1.1.5 The heat treatment of test specimens separately in the device shall be subject to the limitations that (1) cooling rate data for the plate are available; (2) cooling rate control devices for the test specimens are available; and, (3) the method has received prior approval by the purchaser.

11.2 *Orientation*—For plates wider than 24 in. [600 mm], test specimens shall be taken such that the longitudinal axis of the test specimen is transverse to the final direction of rolling of the plate. Test specimens for all other structural products shall be taken such that the longitudinal axis of the test specimen is parallel to the final direction of rolling.

11.3 *Location:*

11.3.1 *Plates*—Test specimens shall be taken from a corner of the plate.

11.3.2 *W and HP Shapes with Flanges 6 in. [150 mm] or Wider*—Test specimens shall be selected from a point in the flange $\frac{2}{3}$ of the way from the flange centerline to the flange toe.

11.3.3 *Shapes Other Than Those in 11.3.2*—Test specimens shall be selected from the webs of beams, channels, and zees; from the stems of rolled tees; and from the legs of angles and bulb angles, except where full-section test specimens for angles are used and the elongation acceptance criteria are increased accordingly. (See 11.6.2.)

11.3.4 *Bars:*

11.3.4.1 Test specimens for bars to be used for pins and rollers shall be taken so that the axis is: midway between the center and the surface for pins and rollers less than 3 in. [75 mm] in diameter; 1 in. [25 mm] from the surface for pins and rollers 3 in. [75 mm] and over in diameter; or as specified in Annex A1 of Test Methods and Definitions A370 if the applicable foregoing requirement is not practicable.

11.3.4.2 Test specimens for bars other than those to be used for pins and rollers shall be taken as specified in Annex A1 of Test Methods and Definitions A370.

11.4 *Test Frequency:*

11.4.1 *Structural Products Produced from an As-Rolled Structural Product*—The minimum number of pieces or plates-as-rolled to be tested for each heat and strength gradation, where applicable, shall be as follows, except that it shall be permissible for any individual test to represent multiple strength gradations:

11.4.1.1 As given in Table B, or

11.4.1.2 One taken from the minimum thickness in the heat and one taken from the maximum thickness in the heat, where thickness means the specified thickness, diameter, or compa-

table dimension, whichever is appropriate for the applicable structural product rolled.

11.4.2 *Structural Products Produced from Coil and Furnished without Heat Treatment or with Stress Relieving Only:*

11.4.2.1 Except as allowed by 11.4.4, the minimum number of coils to be tested for each heat and strength gradation, where applicable, shall be as given in Table C, except that it shall be permissible for any individual coil to represent multiple strength gradations.

11.4.2.2 Except as required by 11.4.2.3, two tension test specimens shall be taken from each coil tested, with the first being taken immediately prior to the first structural product to be qualified, and the second being taken from the approximate center lap.

11.4.2.3 If, during decoiling, the amount of material decoiled is less than that required to reach the approximate center lap, the second test for the qualification of the decoiled portion of such a coil shall be taken from a location adjacent to the end of the innermost portion decoiled. For qualification of successive portions from such a coil, an additional test shall be taken adjacent to the innermost portion decoiled, until a test is obtained from the approximate center lap.

11.4.3 *Structural Products Produced from Coil and Furnished Heat Treated by other than Stress Relieving*—The minimum number of pieces to be tested for each heat and strength gradation, where applicable, shall be as follows, except that it shall be permissible for any individual test to represent multiple strength gradations:

11.4.3.1 As given in Table B, or

11.4.3.2 One taken from the minimum thickness in the heat and one taken from the maximum thickness in the heat, where thickness means the specified thickness, diameter, or comparable dimension, whichever is appropriate for the applicable structural product rolled.

11.4.4 *Structural Products Produced from Coil and Qualified Using Test Specimens Heat Treated by Other than Stress Relieving*—The minimum number of pieces to be tested for each heat and strength gradation, where applicable, shall be as follows, except that it shall be permissible for any individual test to represent multiple strength gradations:

11.4.4.1 As given in Table B, or

11.4.4.2 One taken from the minimum thickness in the heat, where thickness means the specified thickness, diameter, or comparable dimension, whichever is appropriate for the applicable structural product rolled.

11.5 *Preparation:*

11.5.1 *Plates:*

11.5.1.1 Tension test specimens for plates $\frac{3}{4}$ in. [20 mm] and under in thickness shall be the full thickness of the plates. The test specimens shall conform to the requirements shown in Fig. 3 of Test Methods and Definitions A370 for either the $\frac{1}{2}$ -in. [40-mm] wide test specimen or the $\frac{1}{2}$ -in. [12.5-mm] wide test specimen.

11.5.1.2 For plates up to 4 in. [100 mm] inclusive, in thickness, the use of $\frac{1}{2}$ -in. [40-mm] wide test specimens, full thickness of the plate and conforming to the requirements

shown in Fig. 3 of Test Methods and Definitions **A370**, shall be subject to the limitation that adequate testing machine capacity is available.

11.5.1.3 For plates over $\frac{3}{4}$ in. [20 mm] in thickness, except as permitted in **11.5.1.2**, tension test specimens shall conform to the requirements shown in Fig. 4 of Test Methods and Definitions **A370** for the 0.500-in. [12.5-mm] diameter test specimen. The axis of such test specimens shall be located midway between the center of thickness and the top or bottom surface of the plate.

11.5.2 Shapes:

11.5.2.1 Except where angles are tested in full section, tension test specimens for shapes $\frac{3}{4}$ in. [20 mm] and under in

thickness shall be the full thickness of the shape. Such test specimen shall conform to the requirements shown in Fig. 3 of Test Methods and Definitions **A370** for either the $\frac{1}{2}$ -in. [40-mm] wide test specimen or the $\frac{1}{2}$ -in. [12.5-mm] wide test specimen.

11.5.2.2 For shapes up to 5 in. [125 mm] inclusive, in thickness, the use of $1\frac{1}{2}$ -in. [40-mm] wide test specimens, full thickness of the shape and conforming to the requirements shown in Fig. 3 of Test Methods and Definitions **A370**, shall be subject to the limitation that adequate testing machine capacity is available.

TABLE B Minimum Number of Tension Tests Required

Thickness ^A Range Rolled for the Heat	Thickness ^A Difference Between Pieces or Plates-as-rolled in the Thickness ^A Range	Minimum Number of Tension Tests Required
Under $\frac{3}{8}$ in. [10 mm]	$\frac{1}{16}$ in. [2 mm] or less	Two ^B tests per heat, taken from different pieces or plates-as-rolled having any thickness ^A in the thickness ^A range
	More than $\frac{1}{16}$ in. [2 mm]	Two ^B tests per heat, one taken from the minimum thickness ^A in the thickness ^A range and one taken from the maximum thickness ^A in the thickness ^A range
$\frac{3}{8}$ to 2 in. [10 to 50 mm], incl	Less than $\frac{3}{8}$ in. [10 mm]	Two ^B tests per heat, taken from different pieces or plates-as-rolled having any thickness ^A in the thickness ^A range
	$\frac{3}{8}$ in. [10 mm] or more	Two ^B tests per heat, one taken from the minimum thickness ^A in the thickness ^A range and one taken from the maximum thickness ^A in the thickness ^A range
Over 2 in. [50 mm]	Less than 1 in. [25 mm]	Two ^B tests per heat, taken from different pieces or plates-as-rolled having any thickness ^A in the thickness ^A range
	1 in. [25 mm] or more	Two ^B tests per heat, one taken from the minimum thickness ^A in the thickness ^A range and one taken from the maximum thickness ^A in the thickness ^A range

^A Thickness means the specified thickness, diameter, or comparable dimension, whichever is appropriate for the specific structural product rolled.

^B One test, if only one piece or plate-as-rolled is to be qualified.

TABLE C Minimum Number of Coils Required to be Tension Tested

NOTE 1—See **11.4.2.2** and **11.4.2.3** for the number of tests to be taken per coil.

Thickness ^A Difference Between Coils in the Heat	Minimum Number of Coils Required to be Tension Tested
Less than $\frac{1}{16}$ in. [2 mm]	Two ^B coils per heat, at any thickness ^A in the heat
$\frac{1}{16}$ in. [2 mm] or more	Two ^B coils per heat, one at the minimum thickness ^A in the heat and one at the maximum thickness ^A in the heat

^A Thickness means the specified thickness, diameter, or comparable dimension, whichever is appropriate for the specific structural product rolled.

^B One coil, if the product of only one coil is to be qualified.

11.5.2.3 For shapes over $\frac{3}{4}$ in. [20 mm] in thickness, except as permitted in **11.5.2.2**, tension test specimens shall conform to the requirements shown in Fig. 4 of Test Methods and Definitions **A370** for the 0.500-in. [12.5-mm] diameter test specimens. The axis of such test specimens shall be located midway between the center of thickness and the top or bottom surface of the shape.

11.5.3 Bars:

11.5.3.1 Except as otherwise provided below, test specimens for bars shall be in accordance with Annex A1 of Test Methods and Definitions **A370**.

11.5.3.2 Except as provided in **11.5.3.5**, test specimens for bars $\frac{3}{4}$ in. [20 mm] and under in thickness may conform to the requirements shown in Fig. 3 of Test Methods and Definitions **A370** for either the $1\frac{1}{2}$ -in. [40-mm] wide test specimen or the $\frac{1}{2}$ -in. [12.5-mm] wide specimen.

11.5.3.3 Except as provided in **11.5.3.4** and **11.5.3.5**, test specimens for bars over $\frac{3}{4}$ in. [20 mm] in thickness or diameter shall conform either to the requirements for the $1\frac{1}{2}$ -in. [40-mm] or $\frac{1}{2}$ -in. [12.5-mm] wide test specimen shown in Fig. 3 of Test Methods and Definitions **A370**, or to the requirements for the 0.500-in. [12.5-mm] diameter test specimen shown in Fig. 4 of Test Methods and Definitions **A370**.

11.5.3.4 For bars other than those to be used for pins and rollers, the manufacturer or processor shall have the option of using test specimens that are machined to a thickness or diameter of at least $\frac{3}{4}$ in. [20 mm] for a length of at least 9 in. [230 mm].

11.5.3.5 Test specimens for bars to be used for pins and rollers shall conform to the requirements shown in Fig. 4 of Test Methods and Definitions **A370** for the 0.500-in. [12.5-mm] diameter test specimen.

11.6 Elongation Requirement Adjustments:

11.6.1 Due to the specimen geometry effect encountered when using the rectangular tension test specimen for testing thin material, adjustments in elongation requirements must be provided for thicknesses under 0.312 in. [8 mm]. Accordingly, the following deductions from the base elongation requirements shall apply:

Nominal Thickness Range, in. [mm]	Elongation Deduction, %
0.299–0.311 [7.60–7.89]	0.5
0.286–0.298 [7.30–7.59]	1.0
0.273–0.285 [7.00–7.29]	1.5
0.259–0.272 [6.60–6.99]	2.0
0.246–0.258 [6.20–6.59]	2.5
0.233–0.245 [5.90–6.19]	3.0
0.219–0.232 [5.50–5.89]	3.5
0.206–0.218 [5.20–5.49]	4.0
0.193–0.205 [4.90–5.19]	4.5
0.180–0.192 [4.60–4.89]	5.0
0.166–0.179 [4.20–4.59]	5.5 ^A
0.153–0.165 [3.90–4.19]	6.0 ^A
0.140–0.152 [3.60–3.89]	6.5 ^A
0.127–0.139 [3.20–3.59]	7.0 ^A
< 0.127 [3.20]	7.5 ^A

^A Elongation deductions for thicknesses less than 0.180 in. [4.60 mm] apply to plates and structural shapes only.

11.6.2 Due to the specimen geometry effect encountered when using full-section test specimens for angles, the elongation requirements for structural-size angles shall be increased by six percentage points when full-section test specimens are used.

11.6.3 Due to the inherently lower elongation that is obtainable in thicker structural products, adjustments in elongation requirements shall be provided. For structural products over 3.5 in. [90 mm] in thickness, a deduction of 0.5 percentage point from the specified percentage of elongation in 2 in. [50 mm] shall be made for each 0.5-in. [12.5-mm] increment of thickness over 3.5 in. [90 mm], up to a maximum deduction of 3.0 percentage points. Accordingly, the following deductions from the base elongation requirements shall apply:

Nominal Thickness Range, in. [mm]	Elongation Deduction, %
3.500–3.999 [90.00–102.49]	0.5
4.000–4.499 [102.50–114.99]	1.0
4.500–4.999 [115.00–127.49]	1.5
5.000–5.499 [127.50–139.99]	2.0
5.500–5.999 [140.00–152.49]	2.5
6.000 and thicker [152.50 and thicker]	3.0

11.6.4 The tensile property requirements tables in many of the product specifications covered by this general requirements specification specify elongation requirements in both 8-in. [200-mm] and 2-in. [50-mm] gage lengths. Unless otherwise provided in the applicable product specification, both requirements are not required to be applied simultaneously and the elongation need only be determined in the gage length appropriate for the test specimen used. After selection of the appropriate gage length, the elongation requirement for the alternative gage length shall be deemed not applicable.

11.7 Yield Strength Application:

11.7.1 When test specimens do not exhibit a well-defined disproportionate yield point, yield strength shall be determined and substituted for yield point.

11.7.2 The manufacturer or processor shall have the option of substituting yield strength for yield point if the test specimen exhibits a well-defined disproportionate yield point.

11.7.3 Yield strength shall be determined either by the 0.2 % offset method or by the 0.5 % extension-under-load method.

11.8 *Product Tension Tests*—This specification does not provide requirements for product tension testing subsequent to shipment (see 15.1). Therefore, the requirements of 11.1-11.7 inclusive and Section 13 apply only for tests conducted at the place of manufacture prior to shipment.

NOTE 5—Compliance to this specification and the applicable product specification by a manufacturer or processor does not preclude the possibility that product tension test results might vary outside specified ranges. The tensile properties will vary within the same heat or piece, be it as-rolled, control-rolled, or heat-treated. Tension testing according to the requirements of this specification does not provide assurance that all products of a heat will be identical in tensile properties with the products tested. If the purchaser wishes to have more confidence than that provided by this specification testing procedures, additional testing or requirements, such as Supplementary Requirement S4, should be imposed.

11.8.1 **Appendix X2** provides additional information on the variability of tensile properties in plates and structural shapes

12. Permitted Variations in Dimensions and Weight [Mass]

12.1 One cubic foot of rolled steel is assumed to weigh 490 lb. One cubic metre of rolled steel is assumed to have a mass of 7850 kg.

12.2 *Plates*—The permitted variations for dimensions and weight [mass] shall not exceed the applicable limits in Tables 1 to 15 [**Annex A1**, Tables A1.1 to A1.15] inclusive.

12.3 *Shapes*:

12.3.1 **Annex A2** lists the designations and dimensions, in both inch-pound and SI units, of shapes that are most commonly available. Radii of fillets and toes of shape profiles vary with individual manufacturers and therefore are not specified.

12.3.2 The permitted variations in dimensions shall not exceed the applicable limits in Tables 16 to 25 [**Annex A1**, Tables A1.16 to A1.25] inclusive. Permitted variations for special shapes not listed in such tables shall be as agreed upon between the manufacturer and the purchaser.

NOTE 6—Permitted variations are given in Tables 16 to 25 [**Annex A1**, Tables A1.16 to A1.25] inclusive for some shapes that are not listed in **Annex A2** (that is, bulb angles, tees, zeos). Addition of such sections to **Annex A2** will be considered by Subcommittee A01.02 when and if a need for such listing is shown.

12.3.3 *Shapes Having One Dimension of the Cross Section 3 in. [75 mm] or Greater (Structural-Size Shapes)*—The cross-sectional area or weight [mass] of each shape shall not vary more than 2.5 % from the theoretical or specified amounts except for shapes with a nominal weight of less than 100 lb/ft, in which the variation shall range from– 2.5 % to +3.0 % from the theoretical cross-sectional area or the specified nominal weight [mass].

12.4 *Sheet Piling*—The weight [mass] of each steel sheet pile shall not vary more than 2.5 % from the theoretical or specified weight [mass]. The length of each steel sheet pile

shall be not less than the specified length, and not more than 5 in. [125 mm] over the specified length.

12.5 *Hot-Rolled Bars*—The permitted variations in dimensions shall not exceed the applicable limits in Tables 26 to 31 [Annex A1, Tables A1.26 to A1.31] inclusive.

12.6 *Conversion of Permitted Variations from Fractions of an Inch to Decimals*—Permitted variations in dimensions for products covered by this specification are generally given as fractions of an inch and these remain the official permitted variations, where so stated. If the material is to be measured by equipment reporting dimensions as decimals, conversion of permitted variations from fractions of an inch to decimals shall be made to three decimal places; using the rounding method prescribed in Practice E29.

13. Retests

13.1 If any test specimen shows defective machining or develops flaws, the manufacturer or processor shall have the option of discarding it and substituting another test specimen.

13.2 If the percentage of elongation of any tension test specimen is less than that specified and any part of the fracture is more than $\frac{3}{4}$ in. [20 mm] from the center of the gage length of a 2-in. [50-mm] specimen or is outside the middle half of the gage length of an 8-in. [200-mm] specimen, as indicated by scribe scratches marked on the specimen before testing, a retest shall be allowed.

13.3 Except as provided in 13.3.1, if the results from an original tension specimen fails to meet the specified requirements, but are within 2 ksi [14 MPa] of the required tensile strength, within 1 ksi [7 MPa] of the required yield strength or yield point, or within 2 percentage points of the required elongation, a retest shall be permitted to replace the failing test. A retest shall be performed for the failing original test, with the specimen being randomly selected from the heat. If the results of the retest meet the specified requirements, the heat or lot shall be approved.

13.3.1 For structural products that are tested as given in Table C, both tests from each coil tested to qualify a heat are required to meet all mechanical property requirements. Should either test fail to do so, then that coil shall not be used to qualify the heat; however, the portion of that individual coil that is bracketed by acceptable tests (see 11.4.2.3) is considered to be qualified.

13.4 Quenched and tempered steel plates shall be subject to any additional retest requirements contained in the applicable product specification.

13.5 When the full-section option of 11.3.3 is used and the elongation falls below the specified requirement, the manufacturer or processor shall have the option of making another test using a test specimen permitted in 11.5.2.

14. Test Reports

14.1 Test reports for each heat supplied are required and they shall report the following:

14.1.1 The applicable product specification designation, including year-date and whichever of grade, class, and type are specified in the purchase order, to which the structural product is furnished.

14.1.2 The heat number, heat analysis (see 7.1), and nominal sizes.

NOTE 7—If the amount of copper, chromium, nickel, molybdenum, or silicon is less than 0.02 %, the heat analysis for that element may be reported as <0.02 %. If the amount of columbium or vanadium is less than 0.008 %, the heat analysis for that element may be reported as <0.008 %.

14.1.3 For structural products that are tested as given in Table B, two tension test results appropriate to qualify the shipment (see 11.4), except that only one tension test result need be reported if the shipment consists of a single piece or plate-as-rolled.

14.1.3.1 In reporting elongation values, both the percentage increase and the original gage length shall be stated.

14.1.3.2 Yield to tensile ratio when such a requirement is contained in the product specification.

14.1.4 For structural products that are required to be heat treated, either by the applicable product specification or by the purchase order, all heat treatments, including temperature ranges and times at temperature, unless the purchaser and the supplier have agreed to the supply of a heat treatment procedure in place of the actual temperatures and times.

14.1.4.1 Subcritical heat treatment to soften thermally cut edges need not be reported, except for structural products having a specified minimum tensile strength of 95 ksi [655 MPa] or higher, unless such subcritical heating is accomplished at temperatures at least 75°F [40°C] lower than the minimum tempering temperature.

14.1.5 The results of any required austenitic grain size tests (see 8.2 or 8.3, whichever is applicable).

14.1.6 The results of any other test required by the applicable product specification, the applicable supplementary requirements, and the purchase order.

14.2 The thickness of the structural product tested is not necessarily the same as an individual ordered thickness, given that it is the heat that is tested, rather than each ordered item. Tests from specified thicknesses in accordance with 11.4 and encompassing the thicknesses in a shipment shall be sufficient for qualifying the structural product in the shipment. Such test thicknesses are not required to be within previously tested and shipped thicknesses from the same heat.

14.3 For structural products produced from coil that are supplied in the as-rolled condition or have been heat treated by stress relieving only, the test report shall state “Produced from Coil.” Both test results shall be reported for each qualifying coil, and the location within the coil for each test shall be stated.

14.4 For structural products produced from coil, both the manufacturer and the processor shall be identified on the test report.

14.5 When full-section test specimens have been used for the qualification of angles, that information shall be stated on the test report.

14.6 A signature is not required on the test report; however, the document shall clearly identify the organization submitting the report. Notwithstanding the absence of a signature, the organization submitting the report is responsible for the content of the report.

14.7 For structural products finished by other than the original manufacturer, the supplier of the structural product shall also provide the purchaser with a copy of the original manufacturer's test report.

14.8 A test report, certificate of inspection, or similar document printed from or used in electronic form from an electronic data interchange (EDI) transmission shall be regarded as having the same validity as a counterpart printed in the certifier's facility. The content of the EDI transmitted document shall meet the requirements of the applicable product specification and shall conform to any existing EDI agreement between the purchaser and the supplier. Notwithstanding the absence of a signature, the organization submitting the EDI transmission shall be responsible for the content of the report.

NOTE 8—The industry definition as invoked here is: EDI is the computer to computer exchange of business information in a standard format such as ANSI ASC X12.

15. Inspection and Testing

15.1 The inspector representing the purchaser shall have free entry, at all times, while work on the contract of the purchaser is being performed, to all parts of the manufacturer's works that concern the manufacture of the structural product ordered. The manufacturer shall afford the inspector all reasonable facilities to be satisfied that the structural product is being furnished in accordance with this general requirements specification, the applicable product specification, and the purchase order. All tests (except product analysis) and inspection shall be made at the place of manufacture prior to shipment, unless otherwise specified, and shall be conducted so as not to interfere with the operation of the manufacturer's works.

15.2 Where structural products are produced from coil, 15.1 shall apply to the processor instead of the manufacturer, and the place of process shall apply instead of the place of manufacture. Where structural products are produced from coil and the processor is different from the manufacturer, the inspector representing the purchaser shall have free entry at all times while work on the contract of the purchaser is being performed to all parts of the manufacturer's works that concern the manufacture of the structural product ordered.

16. Retreatment

16.1 If any heat-treated structural product fails to meet the mechanical property requirements of the applicable product specification, the manufacturer or the processor shall have the option of heat treating the structural product again. All mechanical property tests shall be repeated and the structural product shall be reexamined for surface defects when it is resubmitted for inspection.

17. Rejection

17.1 Any rejection based upon product analysis made in accordance with the applicable product specification shall be reported to the supplier and samples that represent the rejected structural product shall be preserved for two weeks from the date of notification of such rejection. In case of dissatisfaction with the results of the tests, the supplier shall have the option of making claim for a rehearing within that time.

17.2 The purchaser shall have the option of rejecting structural product that exhibits injurious defects subsequent to its acceptance at the manufacturer's or processor's works, and so notifying the manufacturer or processor.

18. Identification of Structural Products

18.1 *Required Plate Markings:*

18.1.1 Except as allowed by 18.1.4.2 and 18.6, plates shall be legibly marked with the following: applicable ASTM designation (see 1.1) (year-date not required); "G" or "MT" if applicable (see 18.1.2); applicable grade; heat number; size and thickness; and name, brand, or trademark of the manufacturer (for plates produced from an as-rolled structural product) or the processor (for plates produced from coil).

18.1.2 Plates that are required to be heat treated, but have not been so heat treated, shall be marked, by the manufacturer or processor, with the letter "G" (denoting green) following the required ASTM designation mark, except that "G" marking is not necessary if such plates are for shipment, for the purpose of obtaining the required heat treatment, to an organization under the manufacturer's control. Such plates shall have been qualified for shipment on the basis of test specimens that have been so heat treated. Plates that are required to be heat treated, and have been so heat treated, shall be marked, by the party that performed the heat treatment, with the letter "MT" (denoting material treated) following the required ASTM designation mark.

18.1.3 Except as allowed by 18.1.4.2 and 18.6, the required markings for plates shall be by steel die stamping, paint marking, or by means of permanently affixed, colorfast, weather-resistant labels or tags. It shall be the responsibility of the supplier that all required markings be intact and fully legible upon receipt by the purchaser.

18.1.4 *Location of Markings:*

18.1.4.1 The required markings for plates shall be in at least one place on each finished plate.

18.1.4.2 For secured lifts of all sizes of plates $\frac{3}{8}$ in. [10 mm] (or $\frac{5}{16}$ in. [8 mm] for material specified for bridge construction end use) or under in thickness, and for secured lifts of all thicknesses of plates 36 in. [900 mm] or under in width, the manufacturer or processor shall have the option of placing such markings on only the top piece of each lift, or of showing such markings on a substantial tag attached to each lift, unless otherwise specified.

18.2 *Shapes:*

18.2.1 Except as allowed by 18.2.2 and 18.6, shapes shall be marked with the heat number, size of section, length, and mill identification marks on each piece. Shapes with the greatest cross-sectional dimension greater than 6 in. [150 mm] shall have the manufacturer's name, brand, or trademark shown in raised letters at intervals along the length. In addition, shapes shall be identified with the ASTM designation (year-date not required) and grade, either by marking each piece individually, by permanently affixing a colorfast, weather-resistant label or tag, or, if bundled, by attaching a substantial tag to the bundle.

18.2.2 Bundling for shipment of small shapes with the greatest cross-sectional dimension not greater than 6 in. [150

mm] is permissible. Each lift or bundle shall be marked or substantially tagged showing the identification information listed in 18.2.1.

18.2.3 It shall be permissible for the manufacturer to make a full size bundle at the end of a heat by adding product from a consecutively rolled heat of the same nominal chemical composition. The manufacturer shall identify a bundle consisting of product from two heats with the number of the first heat rolled or identify both heats. The manufacturer shall maintain records of the heats contained in each bundle.

18.3 *Steel Sheet Piling*—Steel sheet piling shall be marked with the heat number, size of section, length, and mill identification marks on each piece, either by marking, or by permanently affixing colorfast, weather-resistant label or tag. The manufacturer's name, brand, or trademark shall be shown in raised letters at intervals along the length.

18.4 *Bars*—Bars of all sizes, when loaded for shipment, shall be properly identified with the name or brand of manufacturer, purchaser's name and order number, the ASTM designation number (year-date not required), grade number where appropriate, size and length, weight [mass] of lift, and the heat number for identification. Unless otherwise specified, the method of marking is at the manufacturer's option and shall be made by hot stamping, cold stamping, painting, or marking tags attached to the lifts of bars. Bars are not required to be die-stamped.

18.4.1 It shall be permissible for the manufacturer to make a full size bundle at the end of a heat by adding product from a consecutively rolled heat of the same nominal chemical composition. The manufacturer shall identify a bundle consisting of product from two heats with the number of the first heat rolled or identify both heats. The manufacturer shall maintain records of the heats contained in each bundle.

18.5 *Bar Coding*—In addition to the requirements of 18.1-18.4 inclusive, the manufacturer or processor shall have the option of using bar coding as a supplementary identification method.

NOTE 9—Bar coding should be consistent with AIAG Standards.⁷

18.6 *Subdivided Material*:

18.6.1 Except as allowed by 18.6.2, pieces separated from a master structural product by an organization other than the original manufacturer shall be identified with the ASTM designation (year-date not required), grade, heat number, and the heat treatment identification, if applicable, along with the trademark, brand, or name of the organization subdividing the structural product. The identification methods shall be in accordance with the requirements of 18.1-18.4 inclusive, except that the raised letters method for shapes and steel sheet piling is not required. If the original manufacturer's identification remains intact, the structural product need not be additionally identified by the organization supplying the structural product.

18.6.2 It shall be permissible for pieces from the same heat of structural product to be bundled or placed in secured lifts, with the identification specified in 18.6.1 placed on the top piece of each lift or shown on a substantial tag attached to each bundle or lift.

19. Packaging, Marking, and Loading for Shipment

19.1 Packaging, marking, and loading for shipment shall be in accordance with Practices A700.

19.2 When Level A is specified, and when specified in the contract or order, and for direct procurement by or direct shipment to the U.S. government, preservation, packaging, and packing shall be in accordance with the Level A requirements of MIL-STD-163.

19.3 When specified in the contract or order, and for direct procurement by or direct shipment to the U.S. government, marking for shipment, in addition to requirements specified in the contract or order, shall be in accordance with MIL-STD-129 for military agencies and with Fed. Std. No. 123 for civil agencies.

20. Keywords

20.1 bars; general requirements; plates; rolled; shapes; sheet piling; structural steel

⁷ Available from Automotive Industry Action Group (AIAG), 26200 Lahser Rd., Suite 200, Southfield, MI 48033, <http://www.aiag.org>.

TABLE 1 Permitted Variations in Thickness for Rectangular, Carbon, High-Strength, Low-Alloy, and Alloy-Steel Plates, 15 in. and Under in Thickness When Ordered to Thickness

NOTE 1—Tables 1-31 inclusive contain permitted variations in dimensions and weight stated in inch-pound units.

NOTE 2—Permitted variation under specified thickness, 0.01 in.

NOTE 3—Thickness to be measured at $\frac{3}{8}$ to $\frac{3}{4}$ in. from the longitudinal edge.

NOTE 4—For thicknesses measured at any location other than that specified in Note 3, the permitted variations over specified thickness shall be $1\frac{1}{4}$ times the amounts in this table, rounded to the nearest 0.01 in.

NOTE 5—Where “...” appears in this table, there is no requirement.

Specified Thickness, in.	Permitted Variations Over Specified Thickness for Widths Given in Inches, in.											
	48 and under	Over 48 to 60, excl	60 to 72, excl	72 to 84, excl	84 to 96, excl	96 to 108, excl	108 to 120, excl	120 to 132, excl	132 to 144, excl	144 to 168, excl	168 to 182, excl	182 and over
To $\frac{1}{4}$, excl	0.03	0.03	0.03	0.03	0.03	0.03	0.03	0.03	0.04
$\frac{1}{4}$ to $\frac{5}{16}$, excl	0.03	0.03	0.03	0.03	0.03	0.03	0.03	0.04	0.04
$\frac{5}{16}$ to $\frac{3}{8}$, excl	0.03	0.03	0.03	0.03	0.03	0.03	0.03	0.04	0.04	0.05
$\frac{3}{8}$ to $\frac{7}{16}$, excl	0.03	0.03	0.03	0.03	0.03	0.03	0.04	0.04	0.05	0.06	0.06	...
$\frac{7}{16}$ to $\frac{1}{2}$, excl	0.03	0.03	0.03	0.03	0.03	0.03	0.04	0.04	0.05	0.06	0.06	...
$\frac{1}{2}$ to $\frac{5}{8}$, excl	0.03	0.03	0.03	0.03	0.03	0.03	0.04	0.04	0.05	0.06	0.07	...
$\frac{5}{8}$ to $\frac{3}{4}$, excl	0.03	0.03	0.03	0.03	0.03	0.04	0.04	0.04	0.05	0.06	0.07	0.07
$\frac{3}{4}$ to 1, excl	0.03	0.03	0.03	0.03	0.04	0.04	0.05	0.05	0.06	0.07	0.08	0.09
1 to 2, excl	0.06	0.06	0.06	0.06	0.06	0.07	0.08	0.10	0.10	0.11	0.13	0.16
2 to 3, excl	0.09	0.09	0.09	0.10	0.10	0.11	0.12	0.13	0.14	0.15	0.15	...
3 to 4, excl	0.11	0.11	0.11	0.11	0.11	0.13	0.14	0.14	0.14	0.15	0.17	...
4 to 6, excl	0.15	0.15	0.15	0.15	0.15	0.15	0.15	0.15	0.15	0.20	0.20	...
6 to 10, excl	0.23	0.24	0.24	0.24	0.24	0.24	0.24	0.24	0.24	0.27	0.28	...
10 to 12, excl	0.29	0.29	0.33	0.33	0.33	0.33	0.33	0.33	0.33	0.33	0.35	...
12 to 15, incl	0.29	0.29	0.35	0.35	0.35	0.35	0.35	0.35	0.35	0.35	0.35	...

TABLE 2 Permitted Variations in Weight for Rectangular Sheared Plates and Universal Mill Plates 613.0 lb/ft² and Under When Ordered to Weight

NOTE 1—Permitted variations in overweight for lots of circular and sketch plates shall be $1\frac{1}{4}$ times the amounts in this table.

NOTE 2—Permitted variations in overweight for single plates shall be $1\frac{1}{3}$ times the amounts in this table.

NOTE 3—Permitted variations in overweight for single circular and sketch plates shall be $1\frac{2}{3}$ times the amounts in this table.

NOTE 4—The adopted standard density of rolled steel is 490 lb/ft³.

NOTE 5—Where “...” appears in this table, there is no requirement.

Specified Weights, lb/ft ²	Permitted Variations in Average Weight of Lots ⁴ for Widths Given in Inches, Expressed in Percentage of the Specified Weights per Square Foot																					
	48 and under		Over 48 to 60, excl		60 to 72, excl		72 to 84, excl		84 to 96, excl		96 to 108, excl		108 to 120, excl		120 to 132, excl		132 to 144, excl		144 to 168, excl		168 and over	
	Over	Under	Over	Under	Over	Under	Over	Under	Over	Under	Over	Under	Over	Under	Over	Under	Over	Under	Over	Under	Over	Under
To 10, excl	4.0	3.0	4.5	3.0	5.0	3.0	5.5	3.0	6.0	3.0	7.5	3.0	9.0	3.0	11.0	3.0	13.0	3.0
10 to 12.5, excl	4.0	3.0	4.5	3.0	4.5	3.0	5.0	3.0	5.5	3.0	6.5	3.0	7.0	3.0	8.0	3.0	9.0	3.0	12.0	3.0
12.5 to 15.0, excl	4.0	3.0	4.0	3.0	4.5	3.0	4.5	3.0	5.0	3.0	5.5	3.0	6.0	3.0	7.5	3.0	8.0	3.0	11.0	3.0
15 to 17.5, excl	3.5	3.0	3.5	3.0	4.0	3.0	4.5	3.0	4.5	3.0	5.0	3.0	5.5	3.0	6.0	3.0	7.0	3.0	9.0	3.0	10.0	3.0
17.5 to 20, excl	3.5	2.5	3.5	2.5	3.5	3.0	4.0	3.0	4.5	3.0	4.5	3.0	5.0	3.0	5.5	3.0	6.0	3.0	8.0	3.0	9.0	3.0
20 to 25, excl	3.5	2.5	3.5	2.5	3.5	3.0	3.5	3.0	4.0	3.0	4.0	3.0	4.5	3.0	5.0	3.0	5.5	3.0	7.0	3.0	8.0	3.0
25 to 30, excl	3.0	2.5	3.5	2.5	3.5	2.5	3.5	3.0	3.5	3.0	3.5	3.0	4.0	3.0	4.5	3.0	5.0	3.0	6.5	3.0	7.0	3.0
30 to 40, excl	3.0	2.0	3.0	2.0	3.0	2.0	3.0	2.0	3.5	2.0	3.5	2.5	3.5	2.5	4.0	3.0	4.5	3.0	6.0	3.0	6.5	3.0
40 to 81.7, excl	2.5	2.0	3.0	2.0	3.0	2.0	3.0	2.0	3.5	2.0	3.5	2.0	3.5	2.5	3.5	3.0	4.0	3.0	5.5	3.0	6.0	3.0
81.7 to 122.6, excl	2.5	2.0	3.0	2.0	3.0	2.0	3.0	2.0	3.5	2.0	3.5	2.0	3.5	2.5	3.5	3.0	3.5	3.0	4.0	3.0	4.5	3.0
122.6 to 163.4, excl	2.5	1.5	2.5	1.5	2.5	1.5	2.5	1.5	2.5	2.0	2.5	2.0	2.5	2.0	2.5	2.0	2.5	2.0	3.0	2.0	3.5	2.0
163.4 to 245.1, excl	2.5	1.0	2.5	1.0	2.5	1.0	2.5	1.0	2.5	1.0	2.5	1.0	2.5	1.0	2.5	1.0	2.5	1.0	3.0	1.0	3.5	1.0
245.1 to 409.0, excl	2.5	1.0	2.5	1.0	2.5	1.0	2.5	1.0	2.5	1.0	2.5	1.0	2.5	1.0	2.5	1.0	2.5	1.0	2.5	1.0	3.0	1.0
409.0 to 490.1, excl	2.0	1.0	2.0	1.0	2.5	1.0	2.5	1.0	2.5	1.0	2.5	1.0	2.5	1.0	2.5	1.0	2.5	1.0	2.5	1.0	2.5	1.0
490.1 to 613.0, excl	2.0	1.0	2.0	1.0	2.0	1.0	2.0	1.0	2.5	1.0	2.5	1.0	2.5	1.0	2.5	1.0	2.5	1.0	2.5	1.0	2.5	1.0

⁴ The term “lot” means all the plates of each tabular width and weight group represented in each shipment.

TABLE 3 Permitted Variations in Width and Length for Sheared Plates 1½ in. and Under in Thickness; Length Only of Universal Mill Plates 2½ in. and Under in Thickness

Specified Dimensions, in.		Permitted Variations Over Specified Width and Length ^A for Thicknesses Given in Inches or Equivalent Weights Given in Pounds per Square Foot, in.							
Length	Width	To ⅜, excl		⅜ to ⅝, excl		⅝ to 1, excl		1 to 2, incl ^B	
		To 15.3, excl		15.3 to 25.5, excl		25.5 to 40.8, excl		40.8 to 81.7, incl	
		Width	Length	Width	Length	Width	Length	Width	Length
To 120, excl	To 60, excl	⅜	½	7/16	⅝	½	¾	⅝	1
	60 to 84, excl	7/16	⅝	½	11/16	⅝	7/8	¾	1
	84 to 108, excl	½	¾	⅝	7/8	¾	1	1	1⅛
	108 and over	⅝	7/8	¾	1	7/8	1⅛	1⅛	1¼
120 to 240, excl	To 60, excl	⅜	¾	½	7/8	⅝	1	¾	1⅛
	60 to 84, excl	½	¾	⅝	7/8	¾	1	7/8	1¼
	84 to 108, excl	9/16	7/8	11/16	15/16	13/16	1⅛	1	1⅜
	108 and over	⅝	1	¾	1⅛	7/8	1¼	1⅛	1⅜
240 to 360, excl	To 60, excl	⅜	1	½	1⅛	⅝	1¼	¾	1½
	60 to 84, excl	½	1	⅝	1⅛	¾	1¼	7/8	1½
	84 to 108, excl	9/16	1	11/16	1⅛	7/8	1⅜	1	1½
	108 and over	11/16	1⅛	7/8	1¼	1	1⅜	1¼	1¾
360 to 480, excl	To 60, excl	7/16	1⅛	½	1¼	⅝	1⅜	¾	1⅝
	60 to 84, excl	½	1¼	⅝	1⅜	¾	1½	7/8	1⅝
	84 to 108, excl	9/16	1¼	¾	1⅜	7/8	1½	1	1⅞
	108 and over	¾	1⅜	7/8	1½	1	1⅝	1¼	1⅞
480 to 600, excl	To 60, excl	7/16	1¼	½	1½	⅝	1⅝	¾	1⅞
	60 to 84, excl	½	1⅜	⅝	1½	¾	1⅝	7/8	1⅞
	84 to 108, excl	⅝	1⅜	¾	1½	7/8	1⅝	1	1⅞
	108 and over	¾	1½	7/8	1⅝	1	1¾	1¼	1⅞
600 to 720, excl	To 60, excl	½	1¾	⅝	1⅞	¾	1⅞	7/8	2¼
	60 to 84, excl	⅝	1¾	¾	1⅞	7/8	1⅞	1	2¼
	84 to 108, excl	⅝	1¾	¾	1⅞	7/8	1⅞	1⅛	2¼
	108 and over	7/8	1¾	1	2	1⅛	2¼	1¼	2½
720 and over	To 60, excl	9/16	2	¾	2⅞	7/8	2¼	1	2¾
	60 to 84, excl	¾	2	7/8	2⅞	1	2¼	1⅛	2¾
	84 to 108, excl	¾	2	7/8	2⅞	1	2¼	1¼	2¾
	108 and over	1	2	1⅛	2⅞	1¼	2½	1⅜	3

^A Permitted variation under specified width and length, ¼ in.

^B Permitted variations in length apply also to Universal Mill plates up to 12 in. in width for thicknesses over 2 to 2½ in., incl, except for alloy steel up to 2 in. thick.

TABLE 4 Permitted Variations in Width for Mill Edge Carbon and High-Strength, Low-Alloy Plates Produced on Strip Mills (Applies to Plates Produced from Coil and to Plates Produced from an As-Rolled Structural Product)

Specified Width, in.	Permitted Variation Over Specified Width, in. ^A
To 14, excl	7/16
14 to 17, excl	½
17 to 19, excl	9/16
19 to 21, excl	⅝
21 to 24, excl	11/16
24 to 26, excl	13/16
26 to 28, excl	15/16
28 to 35, excl	1⅛
35 to 50, excl	1¼
50 to 60, excl	1½
60 to 65, excl	1⅝
65 to 70, excl	1¾
70 to 80, excl	1⅞
80 and over	2

^A No permitted variation under specified width.

TABLE 5 Permitted Variations in Rolled Width for Universal Mill Plates 15 in. and Under in Thickness

Specified Width, in.	Permitted Variations Over Specified Width ^A for Thicknesses Given in Inches or Equivalent Weights Given in Pounds per Square Foot, in.					
	To ⅜, excl	⅜ to ⅝, excl	⅝ to 1, excl	1 to 2, incl	Over 2 to 10, incl	Over 10 to 15, incl
	To 15.3, excl	15.3 to 25.5, excl	25.5 to 40.8, excl	40.8 to 81.7, incl	81.7 to 409.0, incl	409.0 to 613.0, incl
Over 8 to 20, excl	⅛	⅛	3/16	¼	⅜	½
20 to 36, excl	3/16	¼	5/16	⅜	7/16	9/16
36 and over	5/16	⅜	7/16	½	9/16	⅝

^A Permitted variation under specified width, ⅛ in.

TABLE 6 Permitted Variations in Diameter for Sheared Circular Plates 1 in. and Under in Thickness

Specified Diameters, in.	Permitted Variations Over Specified Diameter for Thicknesses Given in Inches, in. ^A		
	To 3/8, excl	3/8 to 5/8, excl	5/8 to 1, incl
To 32, excl	1/4	3/8	1/2
32 to 84, excl	5/16	7/16	9/16
84 to 108, excl	3/8	1/2	5/8
108 to 130, excl	7/16	9/16	11/16
130 and over	1/2	5/8	3/4

^A No permitted variation under specified diameter.

TABLE 7 Permitted Variations in Diameter for Gas-Cut Circular Plates (Not Applicable to Alloy Steel)

Specified Diameter, in.	Permitted Variation Over Specified Diameter for Thicknesses Given in Inches, in. ^A					
	to 1, excl	1 to 2, excl	2 to 4, excl	4 to 6, excl	6 to 8, excl	8 to 15, incl
To 32, excl	3/8	3/8	1/2	1/2	5/8	3/4
32 to 84, excl	3/8	1/2	1/2	5/8	3/4	7/8
84 to 108, excl	1/2	9/16	5/8	3/4	7/8	1
108 to 130, excl	1/2	9/16	11/16	7/8	1	11/8
130 and over	3/8	3/4	7/8	1	11/8	11/4

^A No permitted variation under specified diameter.

TABLE 8 Permitted Variations in Width and Length for Rectangular Plates When Gas Cuttings is Specified or Required (Applies to Alloy Steel Specifications Only)

NOTE 1—These permitted variations shall be taken all under or divided over and under, if so specified.

NOTE 2—Plates with universal rolled edges will be gas cut to length only.

Specified Thickness, in.	Permitted Variation Over Specified Width and Length, in.
To 2, excl	3/4
2 to 4, excl	1
4 to 6, excl	1 1/8
6 to 8, excl	1 5/16
8 to 15, incl	1 1/2

TABLE 9 Permitted Variations in Width and Length for Rectangular Plates When Gas Cutting is Specified or Required (Not Applicable to Alloy Steel)

NOTE 1—These permitted variations may be taken all under or divided over and under, if so specified.

NOTE 2—Plates with universal rolled edges will be gas cut to length only.

Specified Thickness, in.	Permitted Variation Over Specified Width and Length, in.
To 2, excl	1/2
2 to 4, excl	5/8
4 to 6, excl	3/4
6 to 8, excl	7/8
8 to 15, incl	1

TABLE 10 Permitted Variations in Diameter for Gas-Cut Circular Plates (Applies to Alloy Steel Specifications Only)

Specified Diameter, in.	Permitted Variations Over Specified Diameter for Specified Thicknesses Given in Inches, in. ^A					
	to 1, excl	1 to 2, excl	2 to 4, excl	4 to 6, excl	6 to 8, excl	8 to 15, incl
To 32, excl	1/2	1/2	3/4	3/4	1	1
32 to 84, excl	1/2	5/8	7/8	1	1 1/8	1 1/4
84 to 108, excl	5/8	3/4	1	1 1/8	1 1/4	1 3/8
108 to 130, incl	7/8	1	1 1/8	1 1/4	1 3/8	1 1/2

^A No permitted variation under specified diameter.

TABLE 11 Permitted Camber^A for Carbon Steel, High-Strength Low-Alloy Steel, and Alloy Steel Universal Mill Plates and High-Strength Low-Alloy Steel and Alloy Steel Sheared, Special-Cut, or Gas-Cut Rectangular Plates

Specified Thickness, in.	Specified Weight, lb/ft ²	Specified Width, in.	Permitted Camber, in.
To 2, incl	to 81.7, incl	all	1/8 × (no. of feet of length/5)
Over 2 to 15, incl	81.7 to 613.0, incl	to 30, incl	3/16 × (no. of feet of length/5)
Over 2 to 15, incl	81.7 to 613.0, incl	over 30	1/4 × (no. of feet of length/5)

^A Camber as it relates to plates is the horizontal edge curvature in the length, measured over the entire length of the plate in the flat position.

TABLE 12 Permitted Camber^A for Sheared Plates and Gas-Cut Rectangular Plates, All Thicknesses (Applies to Carbon Steel Only)

Permitted camber, in. = 1/8 × (number of feet of length/5)

^A Camber as it relates to plates is the horizontal edge curvature in the length, measured over the entire length of the plate in the flat position.

TABLE 13 Permitted Variations From a Flat Surface for Standard Flatness Carbon Steel Plates

NOTE 1—When the longer dimension is under 36 in., the permitted variation from a flat surface shall not exceed ¼ in. When the longer dimension is from 36 to 72 in., incl, the permitted variation from a flat surface shall not exceed 75 % of the tabular amount for the specified width, but in no case less than ¼ in.

NOTE 2—These permitted variations apply to plates that have a specified minimum tensile strength of not more than 60 ksi or comparable chemical composition or hardness. The limits in this table are increased 50 % for plates that have a higher specified minimum tensile strength or comparable chemical composition or hardness.

NOTE 3—This table and these notes cover the permitted variations from a flat surface for circular and sketch plates, based upon the maximum dimensions of such plates.

NOTE 4—Where “...” appears in this table, there is no requirement.

NOTE 5—Plates must be in a horizontal position on a flat surface when flatness is measured.

Specified Thickness, in.	Specified Weight, lb/ft ²	Permitted Variations from a Flat Surface for Specified Widths Given in Inches, in. ^{A,B}										
		To 36, excl	36 to 48, excl	48 to 60, excl	60 to 72, excl	72 to 84, excl	84 to 96, excl	96 to 108, excl	108 to 120, excl	120 to 144, excl	144 to 168, excl	168 and Over
To ¼ , excl	To 10.2, excl	9/16	¾	15/16	1¼	1¾	1½	1⅝	1¾	1⅞
¼ to ⅜ , excl	10.2 to 15.3, excl	½	5/8	¾	15/16	1⅞	1¼	1⅜	1½	1⅝
⅜ to ½ , excl	15.3 to 20.4, excl	½	9/16	5/8	5/8	¾	7/8	1	1⅛	1¼	1⅞	2⅞
½ to ¾ , excl	20.4 to 30.6, excl	7/16	½	9/16	5/8	5/8	¾	1	1	1⅛	1½	2
¾ to 1, excl	30.6 to 40.8, excl	7/16	½	9/16	5/8	5/8	5/8	¾	7/8	1	1⅞	1¾
1 to 2, excl	40.8 to 81.7, excl	¾	½	½	9/16	9/16	5/8	5/8	5/8	1⅛	1⅞	1½
2 to 4, excl	81.7 to 163.4, excl	5/8	¾	7/16	½	½	½	½	½	9/16	5/8	7/8
4 to 6, excl	163.4 to 245.1, excl	¾	7/16	½	½	9/16	9/16	5/8	¾	7/8	7/8	1
6 to 8, excl	245.1 to 326.8, excl	7/16	½	½	5/8	1⅛	¾	7/8	7/8	1	1	1
8 to 10, excl	326.8 to 409.0, excl	½	½	5/8	1⅛	¾	1⅜	7/8	15/16	1	1	1
10 to 12, excl	409.0 to 490.1, excl	½	5/8	¾	1⅜	7/8	15/16	1	1	1	1	1
12 to 15, excl	490.1 to 613.0, incl	5/8	¾	1⅜	7/8	15/16	1	1	1	1	1	...

^A Permitted Variation from a Flat Surface for Length—The longer dimension specified is considered the length, and the permitted variation from a flat surface along the length shall not exceed the tabular amount for the specified width for plates up to 12 ft in length, or in any 12 ft for longer plates.

^B Permitted Variation from a Flat Surface for Width—The permitted variation from a flat surface across the width shall not exceed the tabular amount for the specified width.

TABLE 14 Permitted Variations From a Flat Surface for Standard Flatness High-Strength Low-Alloy Steel and Alloy Steel Plates, Hot Rolled or Thermally Treated

NOTE 1—When the longer dimension is under 36 in., the permitted variation from a flat surface shall not exceed ⅜ in. When the longer dimension is from 36 to 72 in. incl, the permitted variation from a flat surface shall not exceed 75 % of the tabular amount for the specified width.

NOTE 2—This table and these notes cover the permitted variations from a flat surface for circular and sketch plates, based upon the maximum dimensions of such plates.

NOTE 3—Where “...” appears in this table, there is no requirement.

NOTE 4—Plates must be in a horizontal position on a flat surface when flatness is measured.

Specified Thickness, in.	Specified Weight, lb/ft ²	Permitted Variations from a Flat Surface for Specified Widths, in. ^{A,B}										
		To 36, excl	36 to 48, excl	48 to 60, excl	60 to 72, excl	72 to 84, excl	84 to 96, excl	96 to 108, excl	108 to 120, excl	120 to 144, excl	144 to 168, excl	168 and Over
To ¼ , excl	To 10.2 excl	13/16	1⅞	1¾	1⅞	2	2¼	2⅜	2⅝	2¾
¼ to ⅜ , excl	10.2 to 15.3, excl	¾	15/16	1⅞	1¾	1¾	1⅞	2	2¼	2⅜
⅜ to ½ , excl	15.3 to 20.4, excl	¾	7/8	15/16	15/16	1⅞	15/16	1½	1⅝	1⅞	2¾	3⅞
½ to ¾ , excl	20.4 to 30.6, excl	5/8	¾	13/16	7/8	1	1⅞	1¼	1⅜	1⅝	2¼	3
¾ to 1, excl	30.6 to 40.8, excl	5/8	¾	7/8	7/8	15/16	1	1⅞	15/16	1½	2	2⅝
1 to 2, excl	40.8 to 81.7, excl	9/16	5/8	¾	13/16	7/8	15/16	1	1	1	1⅝	2¼
2 to 4, excl	81.7 to 163.4, excl	½	9/16	11/16	¾	¾	¾	¾	¾	7/8	1	1¼
4 to 6, excl	163.4 to 245.1, excl	9/16	11/16	¾	¾	7/8	7/8	15/16	1⅞	1¼	1¼	1½
6 to 8, excl	245.1 to 326.8, excl	5/8	¾	¾	15/16	1	1⅞	1¼	15/16	1½	1½	1½
8 to 10, excl	326.8 to 409.0, excl	¾	13/16	15/16	1	1⅞	1¼	15/16	1⅞	1½	1½	1½
10 to 12, excl	409.0 to 490.1, excl	¾	15/16	1⅞	1¼	15/16	1⅞	1½	1½	1½	1½	1½
12 to 15, incl	490.1 to 613.0, incl	7/8	1	13/16	15/16	1⅞	1½	1½	1½	1½	1½	1½

^A Permitted Variation from a Flat Surface for Length—The longer dimension specified is considered the length, and the permitted variation from a flat surface along the length shall not exceed the tabular amount for the specified width in plates up to 12 ft in length, or in any 12 ft for longer plates.

^B Permitted Variation from a Flat Surface for Width—The permitted variation from a flat surface across the width shall not exceed the tabular amount for the specified width.

TABLE 15 Permitted Variations in Waviness for Standard Flatness Plates

NOTE 1—Waviness denotes the maximum deviation of the surface of the plate from a plane parallel to the surface of the point of measurement and contiguous to the surface of the plate at each of the two adjacent wave peaks, when the plate is resting on a flat horizontal surface, as measured in an increment of less than 12 ft of length. The permitted variation in waviness is a function of the permitted variation from a flat surface as obtained from Table 13 or Table 14, whichever is applicable.

NOTE 2—Plates must be in a horizontal position on a flat surface when waviness is measured.

Permitted Variation from a Flat Surface (from Table 13 or Table 14), in.	Permitted Variation in Waviness, in., When Number of Waves in 12 ft is						
	1	2	3	4	5	6	7
5/16	5/16	1/4	3/16	1/8	1/8	1/16	1/16
3/8	3/8	5/16	3/16	3/16	1/8	1/16	1/16
7/16	7/16	5/16	1/4	3/16	1/8	1/8	1/16
1/2	1/2	3/8	5/16	3/16	3/16	1/8	1/16
9/16	9/16	7/16	5/16	1/4	3/16	1/8	1/8
5/8	5/8	1/2	3/8	1/4	3/16	1/8	1/8
11/16	11/16	1/2	3/8	5/16	3/16	3/16	1/8
3/4	3/4	9/16	7/16	5/16	1/4	3/16	1/8
13/16	13/16	5/8	7/16	5/16	1/4	3/16	1/8
7/8	7/8	11/16	1/2	3/8	1/4	3/16	1/8
15/16	15/16	11/16	1/2	3/8	5/16	1/4	3/16
1	1	3/4	9/16	7/16	5/16	1/4	3/16
1 1/8	1 1/8	7/8	5/8	1/2	3/8	1/4	3/16
1 1/4	1 1/4	15/16	11/16	1/2	3/8	5/16	1/4
1 3/8	1 3/8	1 1/16	3/4	9/16	7/16	5/16	1/4
1 1/2	1 1/2	1 1/8	7/8	5/8	1/2	3/8	1/4
1 5/8	1 5/8	1 1/4	15/16	11/16	1/2	3/8	5/16
1 3/4	1 3/4	15/16	1	3/4	9/16	7/16	5/16
1 7/8	1 7/8	1 7/16	1 1/16	13/16	9/16	7/16	5/16
2	2	1 1/2	1 1/8	7/8	5/8	1/2	3/8
2 1/8	2 1/8	1 5/8	1 9/16	7/8	11/16	1/2	3/8
2 1/4	2 1/4	1 11/16	1 1/4	15/16	11/16	9/16	3/8
2 3/8	2 3/8	1 13/16	1 5/16	1	3/4	9/16	7/16
2 1/2	2 1/2	1 7/8	1 7/16	1 1/16	13/16	9/16	7/16
2 5/8	2 5/8	2	1 1/2	1 1/8	13/16	5/8	7/16
2 3/4	2 3/4	2 1/16	1 9/16	1 1/8	7/8	5/8	1/2
2 7/8	2 7/8	2 3/16	1 5/8	1 3/16	15/16	11/16	1/2
3	3	2 1/4	1 11/16	1 1/4	15/16	11/16	9/16
3 1/8	3 1/8	2 3/8	1 3/4	1 5/16	1	3/4	9/16

TABLE 16 Permitted Variations in Cross Section for W, HP, S, M, C, and MC Shapes

NOTE 1—*A* is measured at center line of web for S, M, and W and HP shapes; at back of web for C and MC shapes. Measurement is overall for C shapes under 3 in. *B* is measured parallel to flange. *C* is measured parallel to web.

NOTE 2—Where “...” appears in this table, there is no requirement.

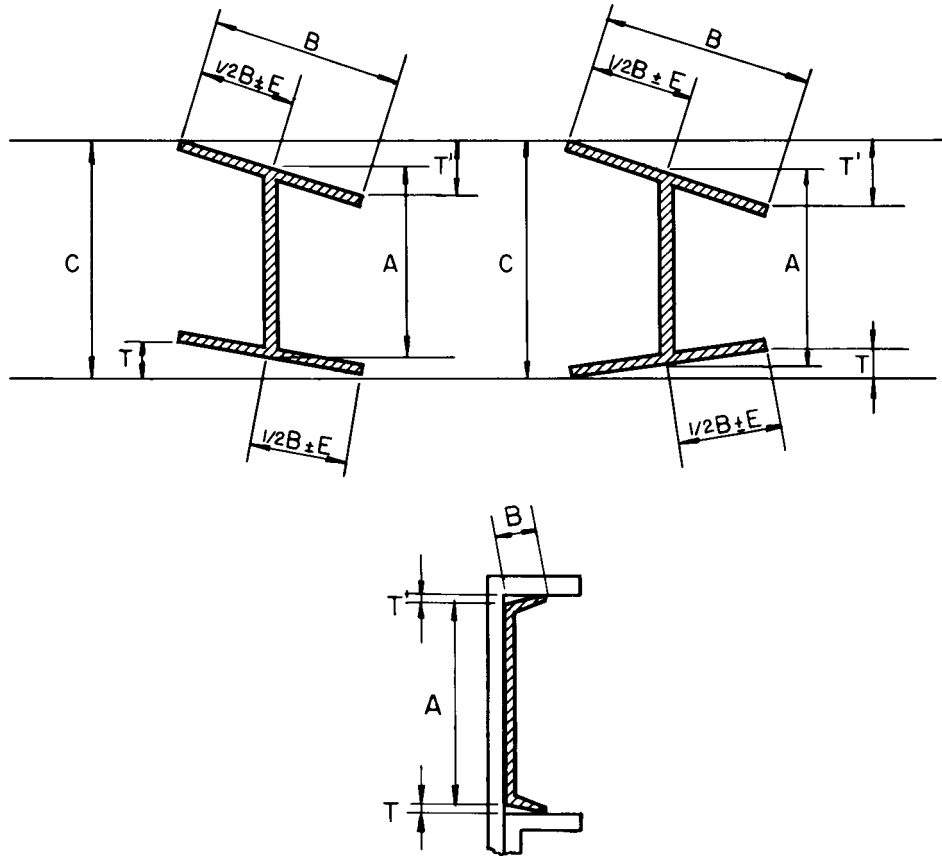

Permitted Variations in Sectional Dimensions Given, in.

Shape	Section Nominal Sizes, in.	A, Depth		B, Flange Width		$T + T'$ ^A Flanges Out-of- Square ^B	E, Web off Cen- ter ^C	C, Maximum Depth at any Cross Section over Theo- retical Depth, in.	Permitted Variations Over or Under Theoreti- cal Web Thickness for Thicknesses Given in Inches, in.	
		Over Theo- retical	Under Theo- retical	Over Theo- retical	Under Theo- retical				³ / ₁₆ and under	Over ³ / ₁₆
W and HP	Up to 12, incl	¹ / ₈	¹ / ₈	¹ / ₄	³ / ₁₆	¹ / ₄	³ / ₁₆	¹ / ₄
	Over 12	¹ / ₈	¹ / ₈	¹ / ₄	³ / ₁₆	⁵ / ₁₆	³ / ₁₆	¹ / ₄
S and M	3 to 7, incl	³ / ₃₂	¹ / ₁₆	¹ / ₈	¹ / ₈	¹ / ₃₂	³ / ₁₆
	Over 7 to 14, incl	¹ / ₈	³ / ₃₂	⁵ / ₃₂	⁵ / ₃₂	¹ / ₃₂	³ / ₁₆
C and MC	Over 14 to 24, incl	³ / ₁₆	¹ / ₈	³ / ₁₆	³ / ₁₆	¹ / ₃₂	³ / ₁₆
	1½ and under	¹ / ₃₂	¹ / ₃₂	¹ / ₃₂	¹ / ₃₂	¹ / ₃₂	0.010	0.015
	Over 1½ to 3, excl	¹ / ₁₆	¹ / ₁₆	¹ / ₁₆	¹ / ₁₆	¹ / ₃₂	0.015	0.020
	3 to 7, incl	³ / ₃₂	¹ / ₁₆	¹ / ₈	¹ / ₈	¹ / ₃₂
	Over 7 to 14, incl	¹ / ₈	³ / ₃₂	¹ / ₈	⁵ / ₃₂	¹ / ₃₂
	Over 14	³ / ₁₆	¹ / ₈	¹ / ₈	³ / ₁₆	¹ / ₃₂

^A $T + T'$ applies when flanges of channels are toed in or out. For channels ⁵/₈ in. and under in depth, the permitted out-of-square is ³/₆₄ in./in. of depth.

^B Permitted variation is per inch of flange width for S, M, C, and MC shapes.

^C Permitted variation of ³/₁₆ in. max for sections over 426 lb/ft.

TABLE 17 Permitted Variations in Cross Section for Angles (L Shapes), Bulb Angles, and Zees

NOTE 1—Where “...” appears in this table, there is no requirement.

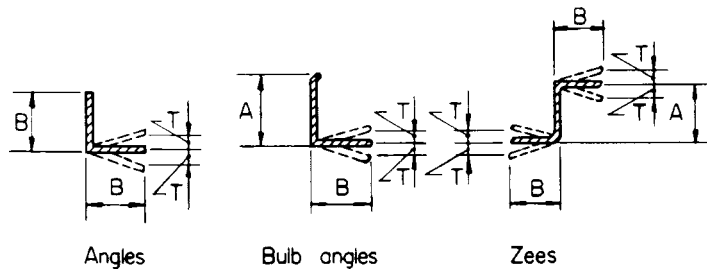

		Permitted Variations in Sectional Dimensions Given, in.						Permitted Variations Over or Under Theoretical Thickness for Thicknesses Given in Inches, in.		
Section	Nominal Size, in.	A, Depth		B, Flange Width or Length of Leg		T, Out-of-Square per Inch of B	$\frac{3}{16}$ and under	Over $\frac{3}{16}$ to $\frac{3}{8}$, incl	Over $\frac{3}{8}$	
		Over Theoretical	Under Theoretical	Over Theoretical	Under Theoretical					
Angles ^A (L Shapes)	1 and under	$\frac{1}{32}$	$\frac{1}{32}$	$\frac{3}{128}B$	0.008	0.010	...	
	Over 1 to 2, incl	$\frac{3}{64}$	$\frac{3}{64}$	$\frac{3}{128}B$	0.010	0.010	0.012	
	Over 2 to 3, excl	$\frac{1}{16}$	$\frac{1}{16}$	$\frac{3}{128}B$	0.012	0.015	0.015	
	3 to 4, incl	$\frac{1}{8}$	$\frac{3}{32}$	$\frac{3}{128}B$	
	Over 4 to 6, incl	$\frac{1}{8}$	$\frac{1}{8}$	$\frac{3}{128}B$	
Bulb angles	Over 6	$\frac{3}{16}$	$\frac{1}{8}$	$\frac{3}{128}B$	
	(Depth) 3 to 4, incl	$\frac{1}{8}$	$\frac{1}{16}$	$\frac{1}{8}$	$\frac{3}{32}$	$\frac{3}{128}B$	
	Over 4 to 6, incl	$\frac{1}{8}$	$\frac{1}{16}$	$\frac{1}{8}$	$\frac{1}{8}$	$\frac{3}{128}B$	
Zees	Over 6	$\frac{1}{8}$	$\frac{1}{16}$	$\frac{3}{16}$	$\frac{1}{8}$	$\frac{3}{128}B$	
	3 to 4, incl	$\frac{1}{8}$	$\frac{1}{16}$	$\frac{1}{8}$	$\frac{3}{32}$	$\frac{3}{128}B$	
	Over 4 to 6, incl	$\frac{1}{8}$	$\frac{1}{16}$	$\frac{1}{8}$	$\frac{1}{8}$	$\frac{3}{128}B$	

^A For unequal leg angles, longer leg determines classification.

^B $\frac{3}{128}$ in./in. = $1\frac{1}{2}^\circ$.

TABLE 18 Permitted Variations in Sectional Dimensions for Rolled Tees

NOTE 1—*Back of square and center line of stem are to be parallel when measuring “out-of-square.”

NOTE 2—Where “...” appears in this table, there is no requirement.

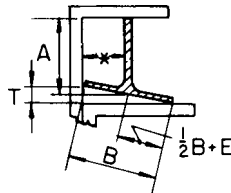

Permitted Variations in Sectional Dimensions Given, in.											
Tees											
Nominal Size, ^A	A, Depth ^B		B, Width ^B		T, Out-of-Square per Inch of B	E, Web-off-Center	Stem Out-of-Square ^C	Thickness of Flange		Thickness of Stem	
	Over	Under	Over	Under				Over	Under	Over	Under
1¼ and under	$\frac{3}{64}$	$\frac{3}{64}$	$\frac{3}{64}$	$\frac{3}{64}$	$\frac{1}{32}$	0.010	0.010	0.005	0.020
Over 1¼ to 2, incl	$\frac{1}{16}$	$\frac{1}{16}$	$\frac{1}{16}$	$\frac{1}{16}$	$\frac{1}{16}$	0.012	0.012	0.010	0.020
Over 2 to 3, excl	$\frac{3}{32}$	$\frac{3}{32}$	$\frac{3}{32}$	$\frac{3}{32}$	$\frac{3}{32}$	0.015	0.015	0.015	0.020
3 to 5, incl	$\frac{3}{32}$	$\frac{1}{16}$	$\frac{1}{8}$	$\frac{1}{8}$	$\frac{1}{32}$	$\frac{3}{32}$
Over 5 to 7, incl	$\frac{3}{32}$	$\frac{1}{16}$	$\frac{1}{8}$	$\frac{1}{8}$	$\frac{1}{32}$	$\frac{1}{8}$

^A The longer member of an unequal tee determines the size for permitted variations.

^B Measurements for both depth and width are overall.

^C Stem-out-of-square is the permitted variation from its true position of the center line of stem, measured at the point.

TABLE 19 Permitted Variations in Length for S, M, C, MC, L, T, Z, and Bulb Angle Shapes

NOTE 1—Where “...” appears in this table, there is no requirement.

Nominal Size, ^A in.	Permitted Variations from Specified Length for Lengths Given in Feet, in.													
	5 to 10, excl		10 to 20, excl		20 to 30, incl		Over 30 to 40, incl		Over 40 to 50, incl		Over 50 to 65, incl		Over 65 ft	
	Over	Under	Over	Under	Over	Under	Over	Under	Over	Under	Over	Under	Over	Under
Under 3	5/8	0	1	0	1 1/2	0	2	0	2 1/2	0	2 1/2	0
3 and over	1	0	1 1/2	0	1 3/4	0	2 1/4	0	2 3/4	0	2 3/4	0

^A Greatest cross-sectional dimension.

TABLE 20 Permitted Variations in End Out-Of-Square for S, M, C, MC, L, T, Z, and Bulb Angle Shapes

Shapes	Permitted Variation
S, M, C, and MC	1/64 in. per inch of depth
L ^A	3/128 in. per inch of leg length or 1 1/2 °
Bulb angles	3/128 in. per inch of depth or 1 1/2 °
Rolled Tees ^A	1/64 in. per inch of flange or stem
Zees	3/128 in. per inch of sum of both flange lengths

^A Permitted variations in end out-of-square are determined on the longer members of the shape.

TABLE 21 Permitted Variations in Straightness for S, M, C, MC, L, T, Z, and Bulb Angle Shapes

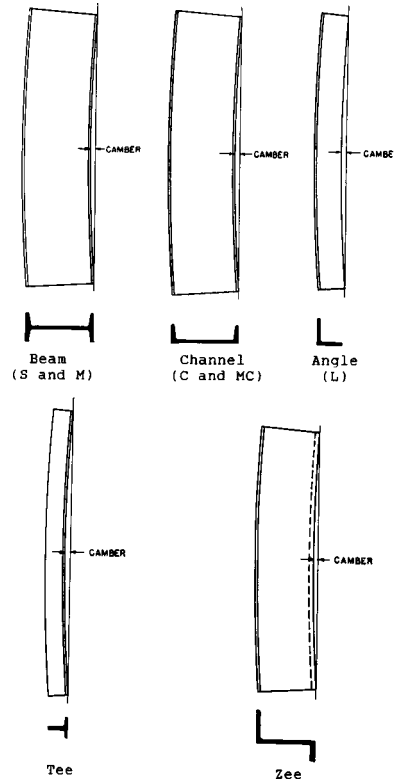

Positions for Measuring Camber of Shapes

Variable	Nominal Size, ^A in.	Permitted Variation, in.
Camber	Under 3	1/4 in. in any 5 ft, or 1/4 × (number of feet of total length/5)
	3 and over	1/8 × (number of feet of total length/5)
Sweep	All	Due to the extreme variations in flexibility of these shapes, permitted variations for sweep are subject to negotiations between the manufacturer and the purchaser for the individual sections involved.

^A Greatest cross-sectional dimension.

TABLE 22 Permitted Variations in Length for W and HP Shapes

W and HP Shapes	Permitted Variations from Specified Length for Lengths Given in Feet, in. ^{A,B}			
	30 and under		Over 30	
	Over	Under	Over	Under
Beams 24 in. and under in nominal depth	3/8	3/8	3/8 plus 1/16 for each additional 5 ft or fraction thereof	
Beams over 24 in. in nominal depth and all columns	1/2	1/2	1/2 plus 1/16 for each additional 5 ft or fraction thereof	

^A For HP and W shapes specified in the order for use as bearing piles, the permitted variations in length are plus 5 in. and minus 0 in. These permitted variations in length also apply to sheet piles.

^B The permitted variations in end out-of-square for W and HP shapes shall be 1/64 in. per inch of depth, or per inch of flange width if the flange width is larger than the depth.

TABLE 23 Permitted Variations in Length and End Out-of-Square, Milled Shapes

Nominal Depth, in.	Length, ft ^B	Permitted Variations in Length and End Out-of-Square, in. ^A					
		Milled Both Ends ^C			Milled One-End ^C		
		Length		End Out-of-Square	Length		End Out-of-Square (for Milled End)
		Over	Under		Over	Under	
6 to 36	6 to 70	1/32	1/32	1/32	1/4	1/4	1/32

^A Length is measured along center line of web. Measurements are made with the steel and tape at the same temperature.

^B The permitted variations in length and end out-of-square are additive.

^C End out-of-square is measured by (a) squaring from the center line of the web and (b) squaring from the center line of the flange. The measured variation from true squareness in either plane shall not exceed the total tabular amount.

TABLE 24 Permitted Variations in Straightness for W and HP Shapes

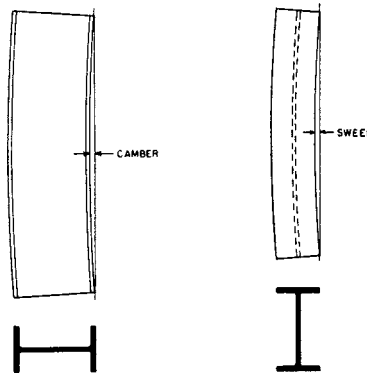

Positions for Measuring Camber and Sweep of W and HP Shapes

	Permitted Variation in Straightness, in.
Camber and sweep	$\frac{1}{8} \times (\text{number of feet of total length}/10)^A$
When certain sections ^B with a flange width approximately equal to depth are specified in the order for use as columns:	
Lengths of 45 ft and under	$\frac{1}{8} \times (\text{number of feet of total length}/10)$ but not over 3/8
Lengths over 45 ft	$\frac{3}{8} + [\frac{1}{8} \times ((\text{number of feet of total length} - 45)/10)]$

^A Sections with a flange width less than 6 in., permitted variation for sweep, in. = $\frac{1}{8} \times (\text{number of feet of total length}/5)$.

^B Applies only to:

- 8-in. deep sections 31 lb/ft and heavier,
- 10-in. deep sections 49 lb/ft and heavier,
- 12-in. deep sections 65 lb/ft and heavier,
- 14-in. deep sections 90 lb/ft and heavier,
- 16-in. deep sections 88 lb/ft and heavier, and
- 18-in. deep sections 135 lb/ft and heavier.

For other sections specified in the order for use as columns, the permitted variation is subject to negotiation with the manufacturer.

TABLE 25 Permitted Variations in Dimensions for Split Tees and Split Angles (L Shapes)^A

Specified Depth, in.	Permitted Variation Over or Under Specified Depth, ^B in.
To 6, excl (beams and channels)	1/8
6 to 16, excl (beams and channels)	3/16
16 to 20, excl (beams and channels)	1/4
20 to 24, excl (beams)	5/16
24 and over (beams)	3/8

^A The permitted variations in length for split tees or angles are the same as those applicable to the section from which the tees or angles are split.

^B The above permitted variations in depth of tees or angles include the permitted variations in depth for the beams or channels before splitting. Permitted variations in dimensions and straightness, as set up for the beams or channels from which these tees or angles are cut, apply, except: straightness = 1/8 in. × (length in feet/5)

TABLE 26 Permitted Variations in Sectional Dimensions for Square-Edge and Round-Edge Flat Bars

NOTE 1—Where “...” appears in this table, there is no requirement.

Specified Widths, in.	Permitted Variations Over or Under Specified Thickness, for Thicknesses Given in Inches, in.							Permitted Variations From Specified Width, in.	
	0.203 to 0.230, excl	0.230 to 1/4, excl	1/4 to 1/2, incl	Over 1/2 to 1, incl	Over 1 to 2, incl	Over 2 to 3, incl	Over 3	Over	Under
To 1, incl	0.007	0.007	0.008	0.010	1/64	1/64
Over 1 to 2, incl	0.007	0.007	0.012	0.015	1/32	1/32	1/32
Over 2 to 4, incl	0.008	0.008	0.015	0.020	1/32	3/64	3/64	1/16	1/32
Over 4 to 6, incl	0.009	0.009	0.015	0.020	1/32	3/64	3/64	3/32	1/16
Over 6 to 8, incl	^A	0.015	0.016	0.025	1/32	3/64	1/16	1/8 ^B	3/32 ^B

^A Flats over 6 to 8 in., incl, in width are not available as hot-rolled carbon steel bars in thickness under 0.230 in.

^B For flats over 6 to 8 in., in width, and to 3 in. incl in thickness.

TABLE 27 Permitted Variations in Sectional Dimensions for Round and Square Bars and Round-Cornered Squares

Specified Size, in.	Permitted Variations from Specified Size, in.		Permitted Out-of-Round or Out-of-Square, in. ^A
	Over	Under	
To 5/16	0.005	0.005	0.008
Over 5/16 to 7/16, incl	0.006	0.006	0.009
Over 7/16 to 5/8, incl	0.007	0.007	0.010
Over 5/8 to 7/8, incl	0.008	0.008	0.012
Over 7/8 to 1, incl	0.009	0.009	0.013
Over 1 to 1 1/8, incl	0.010	0.010	0.015
Over 1 1/8 to 1 1/4, incl	0.011	0.011	0.016
Over 1 1/4 to 1 3/8, incl	0.012	0.012	0.018
Over 1 3/8 to 1 1/2, incl	0.014	0.014	0.021
Over 1 1/2 to 2, incl	1/64	1/64	0.023
Over 2 to 2 1/2, incl	1/32	0	0.023
Over 2 1/2 to 3 1/2, incl	3/64	0	0.035
Over 3 1/2 to 4 1/2, incl	1/16	0	0.046
Over 4 1/2 to 5 1/2, incl	5/64	0	0.058
Over 5 1/2 to 6 1/2, incl	1/8	0	0.070
Over 6 1/2 to 8 1/4, incl	5/32	0	0.085
Over 8 1/4 to 9 1/2, incl	3/16	0	0.100
Over 9 1/2 to 10, incl	1/4	0	0.120

^A Out-of-round is the difference between the maximum and minimum diameters of the bar, measured at the same transverse cross section. Out-of-square section is the difference in perpendicular distance between opposite faces, measured at the same transverse cross section.

TABLE 28 Permitted Variations in Sectional Dimensions for Hexagons

Specified Sizes Between Opposite Sides, in.	Permitted Variations from Specified Size, in.		Permitted Out-of-Hexagon Section, Three Measurements, in. ^A
	Over	Under	
½ and under	0.007	0.007	0.011
Over ½ to 1, incl	0.010	0.010	0.015
Over 1 to 1½, incl	0.021	0.013	0.025
Over 1½ to 2, incl	⅓ ₃₂	⅓ ₆₄	⅓ ₃₂
Over 2 to 2½, incl	⅜ ₆₄	⅓ ₆₄	⅜ ₆₄
Over 2½ to 3½, incl	⅓ ₁₆	⅓ ₆₄	⅓ ₁₆

^A Out-of-hexagon section is the greatest difference in distance between any two opposite faces measured at the same transverse cross section.

TABLE 29 Permitted Variations in Straightness for Bars

Permitted Variations in Straightness, in. ^A
¼ in any 5 ft and ¼ × (number of feet of total length/5)

^A Permitted variations in straightness do not apply to hot-rolled bars if any subsequent heating operation has been performed.

TABLE 30 Permitted Variations in Length for Hot-Cut Steel Bars^A

NOTE 1—Where “...” appears in this table, there is no requirement.

Specified Sizes of Rounds, Squares, and Hexagons, in.	Specified Sizes of Flats, in.		Permitted Variations Over Specified Length Given in Feet, in. (No Variation Under)				
	Thickness	Width	5 to 10, excl	10 to 20, excl	20 to 30, excl	30 to 40, excl	40 to 60, incl
To 1, incl	To 1, incl	To 3, incl	½	¾	1¼	1¾	2¼
Over 1 to 2, incl	Over 1	To 3, incl	⅝	1	1½	2	2½
Over 1 to 2, incl	To 1, incl	Over 3 to 6, incl	⅝	1	1½	2	2½
Over 2 to 5, incl	Over 1	Over 3 to 6, incl	1	1½	1¾	2¼	2¾
Over 5 to 10, incl	2	2½	2¾	3	3¼
	0.230 to 1, incl	Over 6 to 8, incl	¾	1¼	1¾	3½	4
	Over 1 to 3, incl	Over 6 to 8, incl	1¼	1¾	2	3½	4
Hot Sawing							
2 to 5, incl ^B	1 and over	3 and over	^B	1½	1¾	2¼	2¾
Over 5 to 10, incl	^B	2½	2¾	3	3¼

^A For flats over 6 to 8 in., incl, in width and over 3 in. in thickness, consult the manufacturer for permitted variations in length.

^B Smaller sizes and shorter lengths are not commonly hot sawed.

TABLE 31 Permitted Variations in Length for Bars Recut Both Ends After Straightening^{AB}

Sizes of Rounds, Squares, Hexagons, Width of Flats and Maximum Dimension of Other Sections, in.	Permitted Variations from Specified Lengths Given in Feet, in.			
	To 12, incl		Over 12	
	Over	Under	Over	Under
To 3, incl	⅜ ₁₆	⅓ ₁₆	¼	⅓ ₁₆
Over 3 to 6, incl	¼	⅓ ₁₆	⅜ ₈	⅓ ₁₆
Over 6 to 8, incl	⅜ ₈	⅓ ₁₆	½	⅓ ₁₆
Rounds over 8 to 10, incl	½	⅓ ₁₆	⅝ ₈	⅓ ₁₆

^A For flats over 6 to 8 in., incl, in width, and over 3 in. in thickness, consult the manufacturer or processor for permitted variations in length.

^B Permitted variations are sometimes required all over or all under the specified length, in which case the sum of the two permitted variations applies.

SUPPLEMENTARY REQUIREMENTS

The following standardized supplementary requirements are for use when desired by the purchaser. Those that are considered suitable for use with each material specification are listed in the specification. Other tests may be performed by agreement between the supplier and the purchaser. These additional requirements shall apply only when specified in the order, in which event the specified tests shall be made by the manufacturer or processor before shipment of the material.

S1. Vacuum Treatment

S1.1 The steel shall be made by a process that includes vacuum degassing while molten. Unless otherwise agreed upon with the purchaser, it is the responsibility of the manufacturer to select suitable process procedures.

S2. Product Analysis

S2.1 Product analyses shall be made for those elements specified or restricted by the applicable product specification for the applicable grade, class, and type. Specimens for analysis shall be taken adjacent to or from the tension test specimen, or from a sample taken from the same relative location as that from which the tension test specimen was taken.

S3. Simulated Post-Weld Heat Treatment of Mechanical Test Coupons

S3.1 Prior to testing, the test specimens representing the structural product for acceptance purposes for mechanical properties shall be thermally treated to simulate a post-weld heat treatment below the critical temperature (A_{c3}), using the heat treatment parameters (such as temperature range, time, and cooling rates) specified in the order. The test results for such heat-treated test specimens shall meet the applicable product specification requirements.

S4. Additional Tension Test

S4.1 *Plate*—One tension test shall be made from each unit plate rolled from a slab or directly from an ingot, except that for quenched and tempered plates, a test shall be taken from each unit plate heat treated. The results obtained shall be reported on the mill test reports when such tests are required by the order.

S5. Charpy V-Notch Impact Test

S5.1 Charpy V-notch impact tests shall be conducted in accordance with Specification **A673/A673M**.

S5.2 The frequency of testing, the test temperature to be used, and the absorbed energy requirements shall be as specified on the order.

S6. Drop-Weight Test (for Material 0.625 in. [16 mm] and Over in Thickness)

S6.1 Drop-weight tests shall be made in accordance with Test Method **E208**. The specimens shall represent the material in the final condition of heat treatment. Agreement shall be reached between the purchaser and the manufacturer or processor as to the number of pieces to be tested and whether a

maximum nil-ductility transition (NDT) temperature is mandatory or if the test results are for information only.

S8. Ultrasonic Examination

S8.1 The material shall be ultrasonically examined in accordance with the requirements specified on the order.

S15. Reduction of Area Measurement

S15.1 The reduction of area, as determined on the 0.500-in. [12.5-mm] diameter round tension test specimen in accordance with Test Methods and Definitions **A370**, shall not be less than 40 %.

S18. Maximum Tensile Strength

S18.1 Steel having a specified minimum tensile strength of less than 70 ksi [485 MPa] shall not exceed the minimum specified tensile strength by more than 30 ksi [205 MPa].

S18.2 Steel having a minimum specified tensile strength of 70 ksi [485 MPa] or higher shall not exceed the minimum specified tensile strength by more than 25 ksi [170 MPa].

S23. Copper-Bearing Steel (for improved atmospheric corrosion resistance)

S23.1 The copper content shall be a minimum of 0.20 % on heat analysis, 0.18 on product analysis.

S26. Subdivided Material—Marking of Individual Pieces

S26.1 Subdivided pieces shall be individually identified by marking, stenciling, or die stamping the applicable product specification designation (year-date not required), grade, heat number, and the heat treatment identification, if applicable, along with the trademark, brand, or name of the organization that subdivided the structural product. As an alternative, individual subdivided pieces shall be identified by a code traceable to the original required identification, provided that the trademark, name, or brand of the organization that subdivided the structural product is also placed on the structural product and the original required identification, cross referenced on the code, is furnished with the structural product.

S27. Restrictive Plate Flatness

S27.1 As-rolled or normalized carbon steel plates ordered to restrictive flatness shall conform to the permitted variations from a flat surface given in **Table S27.1** or **Table S27.2**, whichever is applicable.

S27.2 As-rolled or normalized high-strength low-alloy steel plates ordered to restrictive flatness shall conform to the permitted variations from a flat surface given in **Table S27.3** or **Table S27.4**, whichever is applicable.

TABLE S27.1 Permitted Variations From a Flat Surface for As-Rolled or Normalized Carbon Steel Plates Ordered to Half-Standard Flatness

NOTE 1—*Permitted Variation From a Flat Surface Along the Length*—The longer dimension specified is considered the length, and the permitted variation from a flat surface along the length shall not exceed the tabular amount for the specified width in plates up to 12 ft in length, or in any 12 ft of longer plates.

NOTE 2—*Permitted Variation From a Flat Surface Across the Width*—The permitted variation from a flat surface across the width shall not exceed the tabular amount for the specified width.

NOTE 3—When the longer dimension is under 36 in., the permitted variation from a flat surface shall not exceed ¼ in. in each direction. When the longer dimension is from 36 to 72 in., incl, the permitted variation from a flat surface shall not exceed 75 % of the tabular amount for the specified width, but in no case less than ¼ in.

NOTE 4—The permitted variations given in this table apply to plates that have a minimum specified tensile strength not over 60 ksi or comparable chemistry or hardness. For plates specified to a higher minimum tensile strength or compatible chemistry or hardness, the permitted variations are 1½ times the amounts in this table.

NOTE 5—This table and these notes cover the permitted variations from a flat surface for circular and sketch plates, based upon the maximum dimensions of such plates.

NOTE 6—Permitted variations in waviness do not apply.

NOTE 7—Plates must be in a horizontal position on a flat surface when flatness is measured.

Specified Thickness, in.	Specified Weights, lb/ft ²	Permitted Variations From a Flat Surface for Specified Widths Given in Inches, in.					
		48 to 60, excl	60 to 72, excl	72 to 84, excl	84 to 96, excl	96 to 108, excl	108 to 120, incl
To ¼, excl	To 10.2, excl	15/32	5/8	11/16	3/4	13/16	7/8
¼ to ⅜, excl	10.2 to 15.3, excl	3/8	15/32	9/16	5/8	11/16	3/4
⅜ to ½, excl	15.3 to 20.4, excl	5/16	5/16	3/8	7/16	1/2	9/16
½ to ¾, excl	20.4 to 30.6, excl	9/32	5/16	5/16	3/8	1/2	1/2
¾ to 1, excl	30.6 to 40.8, excl	9/32	5/16	5/16	5/16	3/8	7/16
1 to 2, incl	40.8 to 51.7, incl	¼	9/32	9/32	5/16	5/16	5/16

TABLE S27.2 Permitted Variations From a Flat Surface for As-Rolled or Normalized Carbon Steel Plates Ordered to Half-Standard Flatness

NOTE 1—*Permitted Variation From a Flat Surface Along the Length*—The longer dimension specified is considered the length, and the permitted variation from a flat surface along the length shall not exceed the tabular amount for the specified width in plates up to 3700 mm in length, or in any 3700 mm of longer plates.

NOTE 2—*Permitted Variation From a Flat Surface Across the Width*—The permitted variation from a flat surface across the width shall not exceed the tabular amount for the specified width.

NOTE 3—When the longer dimension is under 900 mm, the permitted variation from a flat surface shall not exceed 6 mm in each direction. When the longer dimension is from 900 to 1800 mm, incl., the permitted flatness variation should not exceed 75 % of the tabular amount for the specified width, but in no case less than 6 mm.

NOTE 4—The permitted variations given in this table apply to plates that have a minimum specified tensile strength not over 415 MPa or comparable chemistry or hardness. For plates specified to a higher minimum tensile strength or compatible chemistry or hardness, the permitted variations are 1½ times the amounts in this table.

NOTE 5—This table and these notes cover the permitted variations from a flat surface for circular and sketch plates, based upon the maximum dimensions of such plates.

NOTE 6—Permitted variations in waviness do not apply.

NOTE 7—Plates must be in a horizontal position on a flat surface when flatness is measured.

Specified Thickness, mm	Specified Weights, kg/m ²	Permitted Variations From a Flat Surface for Specified Widths Given in Millimetres, mm					
		1200 to 1500, excl	1500 to 1800, excl	1800 to 2100, excl	2100 to 2400, excl	2400 to 2700, excl	2700 to 3000, incl
To 6, excl	To 47.1 excl	12	16	17	19	20	22
6 to 10, excl	47.1 to 78.5, excl.	9	12	14	16	17	19
10 to 12, excl	78.5 to 94.2, excl	8	8	9	11	12	14
12 to 20, excl	94.2 to 157.0, excl	7	8	8	9	12	12
20 to 25, excl	157.0 to 196.2, excl	7	8	8	8	9	11
25 to 50, incl	196.2 to 392.5, incl	6	7	7	8	8	8

TABLE S27.3 Permitted Variations From a Flat Surface for As-Rolled or Normalized High-Strength Low-Alloy Steel Plates Ordered to Half-Standard Flatness

NOTE 1—*Permitted Variation From a Flat Surface Along the Length*—The longer dimension specified is considered the length, and the permitted variation from a flat surface along the length shall not exceed the tabular amount for the specified width in plates up to 12 ft in length, or in any 12 ft of longer plates.

NOTE 2—*Permitted Variation From a Flat Surface Across the Width*—The permitted variation from a flat surface across the width shall not exceed the tabular amount for the specified width.

NOTE 3—When the longer dimension is under 36 in., the permitted variation from a flat surface shall not exceed $\frac{3}{8}$ in. in each direction. When the larger dimension is from 36 to 72 in., incl, the permitted variation from a flat surface shall not exceed 75 % of the tabular amount for the specified width, but in no case less than $\frac{3}{8}$ in.

NOTE 4—This table and these notes cover the permitted variations from a flat surface for circular and sketch plates, based upon the maximum dimensions of those plates.

NOTE 5—Permitted variations in waviness do not apply.

NOTE 6—Plates must be in a horizontal position on a flat surface when flatness is measured.

Specified Thickness, in.	Specified Weights, lb/ft ²	Permitted Variations From a Flat Surface for Specified Widths Given in Inches, in.					
		48 to 60, excl	60 to 72, excl	72 to 84, excl	84 to 96, excl	96 to 108, excl	108 to 120, incl
To $\frac{1}{4}$, excl	To 10.2 excl	$\frac{11}{16}$	$\frac{15}{16}$	1	$1\frac{1}{8}$	$1\frac{3}{16}$	$1\frac{5}{16}$
$\frac{1}{4}$ to $\frac{3}{8}$, excl	10.2 to 15.3, excl	$\frac{9}{16}$	$\frac{11}{16}$	$\frac{7}{8}$	$\frac{15}{16}$	1	$1\frac{1}{8}$
$\frac{3}{8}$ to $\frac{1}{2}$, excl	15.3 to 20.4, excl	$\frac{15}{32}$	$\frac{19}{32}$	$\frac{9}{16}$	$\frac{21}{32}$	$\frac{3}{4}$	$\frac{13}{16}$
$\frac{1}{2}$ to $\frac{3}{4}$, excl	20.4 to 30.6, excl	$\frac{13}{32}$	$\frac{7}{16}$	$\frac{1}{2}$	$\frac{9}{16}$	$\frac{5}{8}$	$\frac{11}{16}$
$\frac{3}{4}$ to 1, excl	30.6 to 40.8, excl	$\frac{7}{16}$	$\frac{7}{16}$	$\frac{19}{32}$	$\frac{1}{2}$	$\frac{9}{16}$	$\frac{21}{32}$
1 to 2, incl	40.8 to 51.7, incl	$\frac{3}{8}$	$\frac{13}{32}$	$\frac{7}{16}$	$\frac{15}{32}$	$\frac{1}{2}$	$\frac{1}{2}$

TABLE S27.4 Permitted Variations From a Flat Surface for As-Rolled or Normalized High-Strength Low-Alloy Steel Plates Ordered to Half-Standard Flatness

NOTE 1—*Permitted Variation From a Flat Surface Along the Length*—The longer dimension specified is considered the length, and the permitted variation from a flat surface along the length shall not exceed the tabular amount for the specified width in plates up to 3700 mm in length, or in any 3700 mm of longer plates.

NOTE 2—*Permitted Variation From a Flat Surface Across the Width*—The permitted variation from a flat surface across the width shall not exceed the tabular amount for the specified width.

NOTE 3—When the longer dimension is under 900 mm, the permitted variation from a flat surface shall not exceed 10 mm in each direction. When the larger dimension is from 900 to 1800 mm, incl., the permitted variation from a flat surface shall not exceed 75 % of the tabular amount for the specified width but in no case less than 10 mm.

NOTE 4—This table and these notes cover the permitted variations from a flat surface for circular and sketch plates, based upon the maximum dimensions of such plates.

NOTE 5—Permitted variations in waviness do not apply.

NOTE 6—Plates must be in a horizontal position on a flat surface when flatness is measured.

Specified Thickness, mm	Specified Weights, kg/m ²	Permitted Variations From a Flat Surface for Specified Widths Given in Millimetres, mm					
		1200 to 1500, excl	1500 to 1800, excl	1800 to 2100, excl	2100 to 2400, excl	2400 to 2700, excl	2700 to 3000, incl
To 6, excl	To 47.1 excl	17	24	25	28	30	33
6 to 10, excl	47.1 to 78.5, excl	14	17	22	24	25	28
10 to 12, excl	78.5 to 94.2, excl	12	12	14	16	19	20
12 to 20, excl	94.2 to 157.0, excl	11	11	12	14	16	17
20 to 25, excl	157.0 to 196.2, excl	11	11	12	12	14	16
25 to 50, incl	196.2 to 392.5, incl	9	10	11	12	12	12

S28. Fine Grain Practice

S28.1 The steel shall be made to fine grain practice.

S29. Fine Austenitic Grain Size

S29.1 The requirements for fine austenitic grain size (see 8.1 and 8.3) shall be met.

**S30. Charpy V-Notch Impact Test for Structural Shapes:
Alternate Core Location**

S30.1 For shapes with a flange thickness equal to or greater than 1½ in. [38.1 mm] that are specified in the purchase order to be tested in accordance with this supplementary requirement, Charpy V-notch impact tests shall be conducted in accordance with Specification **A673/A673M**, using specimens taken from the alternate core location. Unless otherwise specified in the purchase order, the minimum average absorbed energy for each test shall be 20 ft·lbf [27 J] and the test temperature shall be 70°F [21°C].

S30.2 The frequency of testing shall be Frequency (H), except that, for rolled shapes produced from ingots, the frequency shall be Frequency (P) and the specimens shall be

taken from a location representing the top of an ingot or part of an ingot used to produce the product represented by such specimens.

S31. Maximum Carbon Equivalent for Weldability

S31.1 Plates and shapes shall be supplied with a specific maximum carbon equivalent value as specified by the purchaser. This value shall be based upon heat analysis. The required chemical analysis as well as the carbon equivalent shall be reported.

S31.2 The carbon equivalent shall be calculated using the following formula:

$$CE = C + Mn/6 + (Cr + Mo + V)/5 + (Ni + Cu)/15$$

S31.3 For additional information on the weldability of steel, see **Appendix X3**.

S32. Single Heat Bundles

S32.1 Bundles containing shapes or bars shall be from a single heat of steel.

ANNEXES

(Mandatory Information)

A1. PERMITTED VARIATIONS IN DIMENSIONS AND MASS IN SI UNITS

A1.1 **Tables A1.1-A1.31** inclusive contain permitted variations in dimensions and mass stated in SI Units.

TABLE A1.1 Permitted Variations in Thickness for Rectangular Carbon, High-Strength Low Alloy, and Alloy Steel Plates, 300 mm and Under in Thickness When Ordered to Thickness

NOTE 1—Permitted variation under specified thickness, 0.3 mm.

NOTE 2—Thickness to be measured at 10 to 20 mm from the longitudinal edge.

NOTE 3—For specified thicknesses not listed in this table, the permitted variations in thickness shall be as given for the next higher value of specified thickness that is listed in this table.

NOTE 4—For thickness measured at any location other than that specified in **Note 2**, the permitted variations over specified thickness shall be 1¾ times the amounts in this table, rounded to the nearest 0.1 mm.

NOTE 5—Where “...” appears in this table, there is no requirement.

Specified Thickness, mm	Permitted Variations Over Specified Thickness for Widths Given in Millimetres, mm										
	1200 and Under	Over 1200 to 1500, excl	1500 to 1800, excl	1800 to 2100, excl	2100 to 2400, excl	2400 to 2700, excl	2700 to 3000, excl	3000 to 3300, excl	3300 to 3600, excl	3600 to 4200, excl	4200 and Over
5.0	0.8	0.8	0.8	0.8	0.8	0.8	0.8	0.9	1.0
5.5	0.8	0.8	0.8	0.8	0.8	0.8	0.8	0.9	1.0
6.0	0.8	0.8	0.8	0.8	0.8	0.8	0.9	1.0	1.1
7.0	0.8	0.8	0.8	0.8	0.8	0.8	0.9	1.0	1.2	1.4	...
8.0	0.8	0.8	0.8	0.8	0.8	0.8	0.9	1.0	1.2	1.4	...
9.0	0.8	0.8	0.8	0.8	0.8	0.8	1.0	1.0	1.3	1.5	...
10.0	0.8	0.8	0.8	0.8	0.8	0.8	1.0	1.0	1.3	1.5	1.7
11.0	0.8	0.8	0.8	0.8	0.8	0.8	1.0	1.0	1.3	1.5	1.7
12.0	0.8	0.8	0.8	0.8	0.8	0.9	1.0	1.0	1.3	1.5	1.8
14.0	0.8	0.8	0.8	0.8	0.9	0.9	1.0	1.1	1.3	1.5	1.8
16.0	0.8	0.8	0.8	0.8	0.9	0.9	1.0	1.1	1.3	1.5	1.8
18.0	0.8	0.8	0.8	0.8	0.9	1.0	1.1	1.2	1.4	1.6	2.0
20.0	0.8	0.8	0.8	0.8	0.9	1.0	1.2	1.2	1.4	1.6	2.0
22.0	0.8	0.9	0.9	0.9	1.0	1.1	1.3	1.3	1.5	1.8	2.0
25.0	0.9	0.9	1.0	1.0	1.0	1.2	1.3	1.5	1.5	1.8	2.2
28.0	1.0	1.0	1.1	1.1	1.1	1.3	1.4	1.8	1.8	2.0	2.2
30.0	1.1	1.1	1.2	1.2	1.2	1.4	1.5	1.8	1.8	2.1	2.4
32.0	1.2	1.2	1.3	1.3	1.3	1.5	1.6	2.0	2.0	2.3	2.6
35.0	1.3	1.3	1.4	1.4	1.4	1.6	1.7	2.3	2.3	2.5	2.8
38.0	1.4	1.4	1.5	1.5	1.5	1.7	1.8	2.3	2.3	2.7	3.0
40.0	1.5	1.5	1.6	1.6	1.6	1.8	2.0	2.5	2.5	2.8	3.3
45.0	1.6	1.6	1.7	1.8	1.8	2.0	2.3	2.8	2.8	3.0	3.5
50.0	1.8	1.8	1.8	2.0	2.0	2.3	2.5	3.0	3.0	3.3	3.8
55.0	2.0	2.0	2.0	2.2	2.2	2.5	2.8	3.3	3.3	3.5	3.8
60.0	2.3	2.3	2.3	2.4	2.4	2.8	3.0	3.4	3.4	3.8	4.0
70.0	2.5	2.5	2.5	2.6	2.6	3.0	3.3	3.5	3.6	4.0	4.0
80.0	2.8	2.8	2.8	2.8	2.8	3.3	3.5	3.5	3.6	4.0	4.0
90.0	3.0	3.0	3.0	3.0	3.0	3.5	3.5	3.5	3.6	4.0	4.4
100.0	3.3	3.3	3.3	3.3	3.5	3.8	3.8	3.8	3.8	4.4	4.4
110.0	3.5	3.5	3.5	3.5	3.5	3.8	3.8	3.8	3.8	4.4	4.4
120.0	3.8	3.8	3.8	3.8	3.8	3.8	3.8	3.8	3.8	4.8	4.8
130.0	4.0	4.0	4.0	4.0	4.0	4.0	4.0	4.0	4.0	5.2	5.2
140.0	4.3	4.3	4.3	4.3	4.3	4.3	4.3	4.3	4.3	5.6	5.6
150.0	4.5	4.5	4.5	4.5	4.5	4.5	4.5	4.5	4.5	5.6	5.6
160.0	4.8	4.8	4.8	4.8	4.8	4.8	4.8	4.8	4.8	5.6	5.6
180.0	5.4	5.4	5.4	5.4	5.4	5.4	5.4	5.4	5.4	6.3	6.3
200.0	5.8	5.8	6.0	6.0	6.0	6.0	6.0	6.0	6.0	7.0	7.0
250.0	7.5	7.5	7.5	7.5	7.5	7.5	7.5	7.5	7.5	7.5	8.8
300.0	7.5	7.5	9.0	9.0	9.0	9.0	9.0	9.0	9.0	9.0	9.0

TABLE A1.2 Permitted Variations in Mass for Rectangular Sheared Plates and Universal Mill Plates 2983 kg/m² and Under When Ordered to Mass

NOTE 1—Permitted variations in excess mass for lots of circular and sketch plates shall be 1¼ times the amounts in this table.
 NOTE 2—Permitted variations in excess mass for single plates shall be 1⅓ times the amounts in this table.
 NOTE 3—Permitted variations in excess mass for single circular and sketch plates shall be 1½ times the amounts in this table.
 NOTE 4—The adopted standard density for rolled steel is 7850 kg/m³.
 NOTE 5—Where “...” appears in this table, there is no requirement.

Specified Mass, kg/m ²	Permitted Variations in Average Mass of Lots ^A for Widths Given in Millimetres, Expressed in Percentage of the Specified Masses per Square Metre																					
	1200 and Under		Over 1200 to 1500, excl		1500 to 1800, excl		1800 to 2100, excl		2100 to 2400, excl		2400 to 2700, excl		2700 to 3000, excl		3000 to 3300, excl		3300 to 3600, excl		3600 to 4200, excl		4200 and Over	
	Over	Under	Over	Under	Over	Under	Over	Under	Over	Under	Over	Under	Over	Under	Over	Under	Over	Under	Over	Under	Over	Under
To 51.02, excl	4.0	3.0	4.5	3.0	5.0	3.0	5.5	3.0	6.0	3.0	7.5	3.0	9.0	3.0
51.02 to 62.80, excl	4.0	3.0	4.5	3.0	5.0	3.0	5.5	3.0	6.0	3.0	6.5	3.0	7.0	3.0	8.0	3.0	9.0	3.0
62.80 to 74.58, excl	4.0	3.0	4.0	3.0	4.5	3.0	5.0	3.0	5.5	3.0	5.5	3.0	6.0	3.0	7.5	3.0	8.0	3.0	11	3.0
74.58 to 86.35, excl	3.5	3.0	3.5	3.0	4.0	3.0	4.5	3.0	5.0	3.0	5.0	3.0	5.5	3.0	6.0	3.0	7.0	3.0	9.0	3.0	10	3.0
86.35 to 102.0, excl	3.5	2.5	3.5	2.5	3.5	3.0	4.0	3.0	4.5	3.0	4.5	3.0	5.0	3.0	5.5	3.0	6.0	3.0	8.0	3.0	9.0	3.0
102.0 to 125.6, excl	3.5	2.5	3.5	2.5	3.5	3.0	3.5	3.0	4.0	3.0	4.0	3.0	4.5	3.0	5.0	3.0	5.5	3.0	7.0	3.0	8.0	3.0
125.6 to 149.2, excl	3.0	2.5	3.5	2.5	3.5	2.5	3.5	3.0	3.5	3.0	3.5	3.0	4.0	3.0	4.5	3.0	5.0	3.0	6.5	3.0	7.0	3.0
149.2 to 196.2, excl	3.0	2.0	3.0	2.0	3.0	2.0	3.0	2.0	3.5	2.0	3.5	2.5	3.5	2.5	4.0	3.0	4.5	3.0	6.0	3.0	6.5	3.0
196.2 to 392.5, excl	2.5	2.0	3.0	2.0	3.0	2.0	3.0	2.0	3.5	2.0	3.5	2.0	3.5	2.5	3.5	3.0	4.0	3.0	5.5	3.0	6.0	3.0
392.5 to 588.8, excl	2.5	2.0	3.0	2.0	3.0	2.0	3.0	2.0	3.5	2.0	3.5	2.0	3.5	2.5	3.5	3.0	3.5	3.0	4.0	3.0	4.5	3.0
588.8 to 785.0, excl	2.5	1.5	2.5	1.5	2.5	1.5	2.5	1.5	2.5	2.0	2.5	2.0	2.5	2.0	2.5	2.0	2.5	2.0	3.0	2.0	3.5	2.0
785.0 to 1178, excl	2.5	1.0	2.5	1.0	2.5	1.0	2.5	1.0	2.5	1.0	2.5	1.0	2.5	1.0	2.5	1.0	2.5	1.0	3.0	1.0	3.5	1.0
1178 to 1962, excl	2.5	1.0	2.5	1.0	2.5	1.0	2.5	1.0	2.5	1.0	2.5	1.0	2.5	1.0	2.5	1.0	2.5	1.0	2.5	1.0	3.0	1.0
1962 to 2355, excl	2.0	1.0	2.0	1.0	2.5	1.0	2.5	1.0	2.5	1.0	2.5	1.0	2.5	1.0	2.5	1.0	2.5	1.0	2.5	1.0	2.5	1.0
2355 to 2983, incl	2.0	1.0	2.0	1.0	2.0	1.0	2.0	1.0	2.5	1.0	2.5	1.0	2.5	1.0	2.5	1.0	2.5	1.0	2.5	1.0	2.5	1.0

^A The term “lot” means all the plates of each tabular width and mass group represented in each shipment.

TABLE A1.3 Permitted Variations in Width and Length for Sheared Plates 40 mm and Under in Thickness; Length Only of Universal Mill Plates 65 mm and Under in Thickness

Specified Dimensions, mm		Permitted Variations Over Specified Width and Length ^A for Thicknesses Given in Millimetres and Equivalent Masses Given in Kilograms per Square Metre, mm							
		To 10.5, excl		10.5 to 16, excl		16 to 25, excl		25 to 50, incl ^B	
		Length	Width	To 78.50, excl		78.50 to 125.6, excl		125.6 to 196.2, excl	
Width	Length			Width	Length	Width	Length	Width	Length
To 3000, excl	To 1500, excl	10	13	11	16	13	19	16	25
	1500 to 2100, excl	11	16	13	18	16	22	19	25
	2100 to 2700, excl	13	19	16	22	19	25	25	29
	2700 and over	16	22	19	25	22	29	29	32
3000 to 6000, excl	To 1500, excl	10	19	13	22	16	25	19	29
	1500 to 2100, excl	13	19	16	22	19	25	22	32
	2100 to 2700, excl	14	22	18	24	21	29	25	35
	2700 and over	16	25	19	29	22	32	29	35
6000 to 9000, excl	To 1500, excl	10	25	13	29	16	32	19	38
	1500 to 2100, excl	13	25	16	29	19	32	22	38
	2100 to 2700, excl	14	25	18	32	22	35	25	38
	2700 and over	18	29	22	32	25	35	32	44
9000 to 12 000, excl	To 1500, excl	11	29	13	32	16	35	19	41
	1500 to 2100, excl	13	32	16	35	19	38	22	41
	2100 to 2700, excl	14	32	19	35	22	38	25	48
	2700 and over	19	35	22	38	25	41	32	48
12 000 to 15 000, excl	To 1500, excl	11	32	13	38	16	41	19	48
	1500 to 2100, excl	13	35	16	38	19	41	22	48
	2100 to 2700, excl	16	35	19	38	22	41	25	48
	2700 and over	19	38	22	41	25	44	32	48
15 000 to 18 000, excl	To 1500, excl	13	44	16	48	19	48	22	57
	1500 to 2100, excl	16	44	19	48	22	48	25	57
	2100 to 2700, excl	16	44	19	48	22	48	29	57
	2700 and over	22	44	25	51	29	57	32	64
18 000 and over	To 1500, excl	14	51	19	54	22	57	25	70
	1500 to 2100, excl	19	51	22	54	25	57	29	70
	2100 to 2700, excl	19	51	22	54	25	57	32	70
	2700 and over	25	51	29	60	32	64	35	76

^A Permitted variations under specified width and length, 6 mm.

^B Permitted variations in length apply also to Universal Mill plates up to 300 mm in width for thicknesses over 50 to 65 mm, incl, except for alloy steel up to 50 mm thick.

TABLE A1.4 Permitted Variations in Width for Mill Edge Carbon and High Strength Low-Alloy Plates Produced on Strip Mills (Applies to Plates Produced from Coil and to Plates Produced from an As-Rolled Structural Product)

Specified Width, mm	Permitted Variation Over Specified Width, mm ^A
To 360, excl	11
360 to 430, excl	13
430 to 480, excl	14
480 to 530, excl	16
530 to 610, excl	17
610 to 660, excl	21
660 to 710, excl	24
710 to 890, excl	29
890 to 1270, excl	32
1270 to 1520, excl	38
1520 to 1650, excl	41
1650 to 1780, excl	44
1780 to 2030, excl	47
2030 and over	51

^A No permitted variation under specified width.

TABLE A1.5 Permitted Variations in Rolled Width for Universal Mill Plates 380 mm and Under in Thickness

Specified Width, mm	Permitted Variations Over Specified Width ^A for Thickness Given in Millimetres or Equivalent Masses Given in Kilograms per Square Metre, mm					
	To 10, excl	10 to 16, excl	16 to 25, incl	25 to 50, incl	Over 50 to 250, incl	Over 250 to 400, incl
	To 78.50, excl	78.50 to 125.6, excl	125.6 to 196.2, excl	196.2 to 392.5, incl	Over 392.5 to 1962, incl	Over 1962 to 3140, incl
Over 200 to 500, excl	3	3	5	6	10	13
500 to 900, excl	5	6	8	10	11	14
900 and over	8	10	11	13	14	16

^A Permitted variation under specified width, 3 mm.

TABLE A1.6 Permitted Variations in Diameter for Sheared Circular Plates 25 mm and Under in Thickness

Specified Diameters, mm	Permitted Variations Over Specified Diameter for Thicknesses Given in Millimetres, mm ⁴		
	To 10, excl	10 to 16, excl	16 to 25, incl
To 800, excl	6	10	13
800 to 2100, excl	8	11	14
2100 to 2700, excl	10	13	16
2700 to 3300, excl	11	14	17
3300 and over	13	16	19

⁴ No permitted variation under specified diameter.

TABLE A1.7 Permitted Variations in Diameter for Gas-Cut Circular Plates (Not Applicable to Alloy Steel)

Specified Diameters, mm	Permitted Variation Over Specified Diameter for Thicknesses Given, mm ⁴					
	To 25, excl	25 to 50, excl	50 to 100, excl	100 to 150, excl	150 to 200, excl	200 to 400, incl
To 800, excl	10	10	13	13	16	19
800 to 2100, excl	10	13	13	16	19	22
2100 to 2700, excl	13	14	16	19	22	25
2700 to 3300, excl	13	14	17	22	25	29
3300 and over	16	19	22	25	29	32

⁴ No permitted variations under specified diameter.

TABLE A1.8 Permitted Variations in Width and Length for Rectangular Plates When Gas Cutting is Specified or Required (Applies to Alloy Steel Specifications Only)

NOTE 1—Plates with universal rolled edges will be gas cut to length only.

NOTE 2—These permitted variations shall be taken all under or divided over and under, if so specified.

Specified Thickness, mm	Permitted Variation Over Specified Width and Length, mm
To 50, excl	19
50 to 100, excl	25
100 to 150, excl	29
150 to 200, excl	33
200 to 400, excl	38

TABLE A1.9 Permitted Variations in Width and Length for Rectangular Plates When Gas Cutting is Specified or Required (Not Applicable to Alloy Steel)

NOTE 1—Plates with universal rolled edges will be gas cut to length only.

Specified Thickness, mm	Permitted Variation Over Specified Width and Length, mm ⁴
To 50, excl	13
50 to 100, excl	16
100 to 150, excl	19
150 to 200, excl	22
200 to 400, incl	25

⁴ These permitted variations shall be taken all under or divided over and under, if so specified.

TABLE A1.10 Permitted Variations in Diameter for Gas-Cut Circular Plates (Applies to Alloy Steel Specifications Only)

Specified Diameter, mm	Permitted Variations Over Specified Diameter for Specified Thicknesses Given in Millimetres, mm ^A					
	To 25, excl	25 to 50, excl	50 to 100, excl	100 to 150, excl	150 to 200, excl	200 to 400, incl
To 800, excl	13	13	19	19	25	25
800 to 2100, excl	13	16	22	25	29	32
2100 to 2700, excl	16	19	25	29	32	35
2700 to 3300, incl	22	25	29	32	35	38

^A No permitted variations under specified diameter.

TABLE A1.11 Permitted Camber^A for Carbon Steel, High-Strength Low-Alloy Steel, and Alloy Steel Universal Mill Plates and High-Strength Low-Alloy Steel and Alloy Steel Sheared or Gas-Cut Rectangular Plates

Specified Width, mm	Permitted Camber, mm
To 750, incl	Length in millimetres/300
Over 750 to 1500	Length in millimetres/250

^A Camber as it relates to plates is the horizontal edge curvature in the length, measured over the entire length of the plate in the flat position.

TABLE A1.12 Permitted Camber^A for Sheared Plates and Gas-Cut Rectangular Plates, All Thicknesses (Applies to Carbon Steel Only)

Permitted camber, mm = length in millimetres/500
--

^A Camber as it relates to plates is the horizontal edge curvature in the length, measured over the entire length of the plate in the flat position.

TABLE A1.13 Permitted Variations From a Flat Surface for Standard Flatness Carbon Steel Plates

NOTE 1—When the longer dimension is under 900 mm, the permitted variation from a flat surface shall not exceed 6 mm. When the longer dimension is from 900 to 1800 mm, incl, the permitted variation from a flat surface shall not exceed 75 % of the tabular amount for the specified width, but in no case less than 6 mm.

NOTE 2—These permitted variations apply to plates that have a specified minimum tensile strength of not more than 415 MPa or comparable chemical composition or hardness. The limits in this table are increased 50 % for plates that have a higher specified minimum tensile strength or comparable chemical composition or hardness.

NOTE 3—This table and these notes cover the permitted variations from a flat surface for circular and sketch plates, based upon the maximum dimensions of such plates.

NOTE 4—Where “...” appears in this table, there is no requirement.

NOTE 5—Plates must be in a horizontal position on a flat surface when flatness is measured.

Specified Thickness, mm	Specified Mass, kg/m ²	Permitted Variations From a Flat Surface for Specified Widths Given in Millimetres, mm ^{A,B}										
		To 900, excl	900 to 1200, excl	1200 to 1500, excl	1500 to 1800, excl	1800 to 2100, excl	2100 to 2400, excl	2400 to 2700, excl	2700 to 3000, excl	3000 to 3600, excl	3600 to 4200, excl	4200 and over
To 6, excl	To 47.1, excl	14	19	24	32	35	38	41	44	48
6 to 10, excl	47.1 to 78.5, excl	13	16	19	24	29	32	35	38	41
10 to 12, excl	78.5 to 94.2, excl	13	14	16	16	19	22	25	29	32	48	54
12 to 20, excl	94.2 to 157.0, excl	11	13	14	16	16	19	25	25	29	38	51
20 to 25, excl	157.0 to 196.2, excl	11	13	14	16	16	16	19	22	25	35	44
25 to 50, excl	196.2 to 392.5, excl	10	13	13	14	14	16	16	16	18	29	38
50 to 100, excl	392.5 to 785.0, excl	8	10	11	13	13	13	13	14	16	22	29
100 to 150, excl	785.0 to 1178, excl	10	11	13	13	14	14	16	19	22	22	25
150 to 200, excl	1178 to 1570, excl	11	13	13	16	18	19	22	22	25	25	25
200 to 250, excl	1570 to 1962, excl	13	13	16	18	19	21	22	24	25	25	25
250 to 300, excl	1962 to 2355, excl	13	16	19	21	22	24	25	25	25	25	25
300 to 400, incl	2355 to 3140, incl	16	19	21	22	24	25	25	25	25	25	...

^A Permitted Variation From a Flat Surface Along the Length—The longer dimension specified is considered the length, and the permitted variation from a flat surface along the length shall not exceed the tabular amount for the specified width for plates up to 4000 mm in length, or in any 4000 mm for longer plates.

^B Permitted Variation From a Flat Surface Across the Width—The permitted variation from a flat surface across the width shall not exceed the tabular amount for the specified width.

TABLE A1.14 Permitted Variations From a Flat Surface for Standard Flatness High-Strength Low-Alloy Steel and Alloy Steel Plates, Hot Rolled or Thermally Treated

NOTE 1—When the longer dimension is under 900 mm, the permitted variation from a flat surface shall not exceed 10 mm. When the longer dimension is from 900 to 1800 mm, incl, the permitted variation from a flat surface shall not exceed 75 % of the tabular amount for the specified width.

NOTE 2—This table and these notes cover the permitted variations from a flat surface for circular and sketch plates, based upon the maximum dimensions of such plates.

NOTE 3—Where “...” appears in this table, there is no requirement.

NOTE 4—Plates must be in a horizontal position on a flat surface when flatness is measured.

Specified Thickness, mm	Specified Mass, kg/m ²	Permitted Variations from a Flat Surface for Specified Widths Given in Millimetres, mm ^{A,B}										
		To 900, excl	900 to 1200, excl	1200 to 1500, excl	1500 to 1800, excl	1800 to 2100, excl	2100 to 2400, excl	2400 to 2700, excl	2700 to 3000, excl	3000 to 3600, excl	3600 to 4200, excl	4200 and over
To 6, excl	To 47.1, excl	21	29	35	48	51	57	60	67	70
6 to 10, excl	47.1 to 78.5, excl	19	24	29	35	44	48	51	57	60
10 to 12, excl	78.5 to 94.2, excl	19	22	24	24	29	33	38	41	48	70	79
12 to 20, excl	94.2 to 157.0, excl	16	19	22	22	25	29	32	35	41	57	76
20 to 25, excl	157.0 to 196.2, excl	16	19	22	22	24	25	29	33	38	51	67
25 to 50, excl	196.2 to 392.5, excl	14	16	19	21	22	24	25	25	25	41	57
50 to 100, excl	392.5 to 785.0, excl	13	14	18	19	19	19	19	22	25	32	41
100 to 150, excl	785.0 to 1178, excl	14	18	19	19	22	22	24	29	32	32	38
150 to 200, excl	1178 to 1570, excl	16	19	19	24	25	29	32	33	38	38	38
200 to 250, excl	1570 to 1962, excl	19	21	24	25	29	32	33	35	38	38	38
250 to 300, excl	1962 to 2355, excl	19	24	29	32	33	35	38	38	38	38	38
300 to 400, incl	2355 to 3140, incl	22	25	30	33	35	38	38	38	38	38	38

^A Permitted Variation From a Flat Surface Along the Length—The longer dimension specified is considered the length, and the permitted variation from a flat surface along the length shall not exceed the tabular amount for the specified width in plates up to 4000 mm in length, or in any 4000 mm for longer plates.

^B Permitted Variation From a Flat Surface Across the Width—The permitted variation from a flat surface across the width shall not exceed the tabular amount for the specified width.

TABLE A1.15 Permitted Variations in Waviness for Standard Flatness Plates

NOTE 1—Waviness denotes the maximum deviation of the surface of the plate from a plane parallel to the surface of the point of measurement and contiguous to the surface of the plate at each of the two adjacent wave peaks, when the plate is resting on a flat horizontal surface, as measured in an increment of less than 4000 mm of length. The permitted variation in waviness is a function of the permitted variation from a flat surface as obtained from [Table A1.13](#) or [Table A1.14](#), whichever is applicable.

NOTE 2—Plates must be in a horizontal position on a flat surface when waviness is measured.

Permitted Variation from a Flat Surface (from Table Table A1.13 or Table A1.14), mm	Permitted Variations in Waviness, mm, When Number of Waves in 4000 mm is						
	1	2	3	4	5	6	7
8	8	6	5	3	3	2	2
10	10	8	5	5	3	2	2
11	11	8	6	5	3	3	2
13	13	10	8	5	5	3	2
14	14	11	8	6	5	3	2
16	16	13	10	6	5	3	2
17	17	13	10	8	5	5	2
19	19	14	11	8	6	5	2
21	21	16	11	8	6	5	2
22	22	17	13	10	6	5	2
24	24	17	13	10	8	6	5
25	25	19	14	11	8	6	5
29	29	22	16	13	10	6	5
32	32	24	17	13	10	8	6
35	35	27	19	14	11	8	6
38	38	29	22	16	13	10	6
41	41	32	24	17	13	10	8
44	44	33	25	19	14	11	8
48	48	37	27	21	14	11	8
51	51	38	29	22	16	13	10
54	54	41	30	22	17	13	10
57	57	43	32	24	17	14	10
60	60	46	33	25	19	14	11
64	64	48	37	27	21	14	11
67	67	51	38	29	21	16	11
70	70	52	40	29	22	16	13
73	73	56	41	30	24	17	13
76	76	57	43	32	24	17	14
79	79	60	44	33	25	19	14

TABLE A1.16 Permitted Variations in Cross Section for W, HP, S, M, C, and MC Shapes

NOTE 1—*A* is measured at center lines of web for S, M, W, and HP shapes; at back of web for C and MC shapes. Measurement is overall for C shapes under 75 mm. *B* is measured parallel to flange. *C* is measured parallel to web.

NOTE 2—Where “...” appears in this table, there is no requirement.

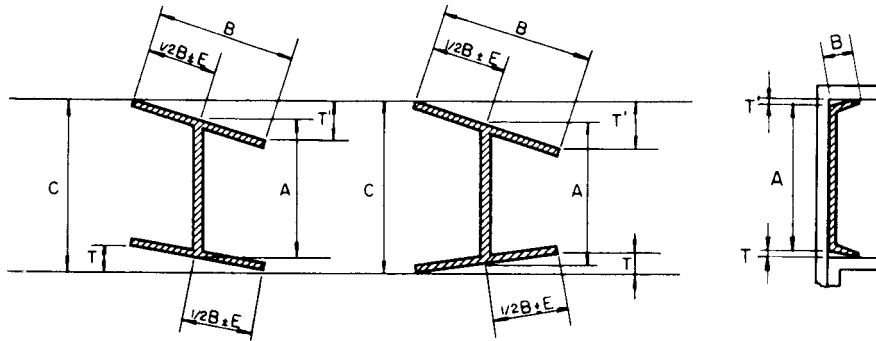

Permitted Variations in Sectional Dimensions Given, mm

Shape	Section Nominal Size, mm	A, Depth				B, Flange Width		$T + T'$ ^A Flanges Out-of-Square ^B	E, Web off Center ^C	C, Maximum Depth at any Cross Section over Theoretical Depth	Permitted Variations Over or Under Theoretical Web Thickness for Thicknesses Given in Millimetres, mm	
		Over Theoretical	Under Theoretical	Over Theoretical	Under Theoretical	5 and Under	Over 5					
		W and HP	up to 310, incl over 310	4 4	3 3	6 6	5 5				6 8	5 5
S and M	75 to 180, incl over 180 to 360, incl over 360 to 610, incl	2 3 5	2 2 3	3 4 5	3 4 5	0.03 0.03 0.03	5 5 5		
C and MC	40 and under over 40 to 75, excl 75 to 180, incl over 180 to 360, incl over 360	1 2 3 3 5	1 2 2 3 4	1 2 3 3 3	1 2 3 4 5	0.03 0.03 0.03 0.03 0.03	0.2 0.4	0.4 0.5		

^A $T + T'$ applies when flanges of channels are toed in or out. For channels 16 mm and under in depth, the permitted out-of-square is 0.05 mm/mm of depth. The permitted variation shall be rounded to the nearest millimetre after calculation.

^B Permitted variation is per millimetre of flange width for S, M, C, and MC shapes.

^C Permitted variation of 8 mm max for sections over 634 kg/m.

TABLE A1.17 Permitted Variations in Cross Section for Angles (L Shapes), Bulb Angles, and Zees

NOTE 1—Where “...” appears in this table, there is no requirement.

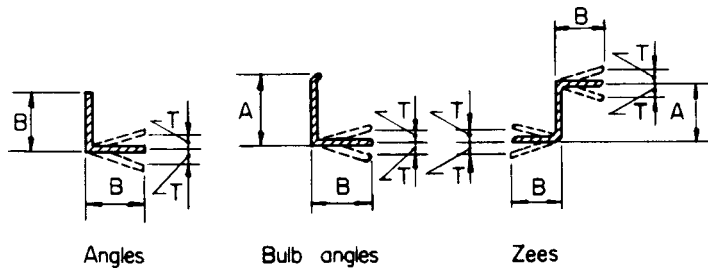

		Permitted Variations in Sectional Dimensions Given, mm							
Section	Nominal Size, mm	A, Depth		B, Flange Width, or Length of Leg		T, Out-of-Square per Millimetre of B	Permitted Variations Over or Under Theoretical Thickness for Thicknesses Given in Millimetres, mm		
		Over Theoretical	Under Theoretical	Over Theoretical	Under Theoretical		5 and Under	Over 5 to 10	Over 10
Angles ^A (L shapes)	25 and under	1	1	0.026 ^B	0.2	0.2	...
	over 25 to 50, incl	1	1	0.026 ^B	0.2	0.2	0.3
	over 50 to 75, excl	2	2	0.026 ^B	0.3	0.4	0.4
	75 to 100, incl	3	2	0.026 ^B
	over 100 to 150 incl	3	3	0.026 ^B
Bulb angles	over 150	5	3	0.026 ^B
	(depth) 75 to 100, incl	3	2	4	2	0.026 ^B
	over 100 to 150, incl	3	2	4	3	0.026 ^B
Zees	over 150	3	2	5	3	0.026 ^B
	75 to 100, incl	3	2	4	2	0.026 ^B
	over 100 to 150, incl	3	2	4	3	0.026 ^B

^A For unequal leg angles, longer leg determines classification.

^B 0.026 mm/mm = 1½°. The permitted variation shall be rounded to the nearest millimetre after calculation.

TABLE A1.18 Permitted Variations in Sectional Dimensions for Rolled Tees

NOTE 1—*Back of square and center line of stem are to be parallel when measuring “out-of-square.”

NOTE 2—Where “...” appears in this table, there is no requirement.

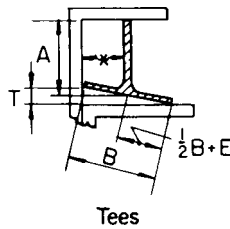

		Permitted Variations in Sectional Dimensions Given, mm									
Nominal Size ^A	A, Depth ^B		B, Width ^B		T, Out-of-Square per Millimetre of B	E, Web Off-Center, max	Stem Out-of-Square ^C	Thickness of Flange		Thickness of Stem	
	Over	Under	Over	Under				Over	Under	Over	Under
30 and under	1	1	1	1	1	0.2	0.2	0.1	0.5
Over 30 to 50, incl	2	2	2	2	2	0.3	0.3	0.2	0.5
Over 50 to 75, excl	2	2	2	2	2	0.4	0.4	0.4	0.5
75 to 125, incl	2	2	3	3	0.03	2
Over 125 to 180, incl	2	2	3	3	0.03	3

^A The longer member of an unequal tee determines the size for permitted variations.

^B Measurements for both depth and width are overall.

^C Stem out-of-square is the permitted variation from its true position of the center line of stem, measured at the point.

TABLE A1.19 Permitted Variations in Length for S, M, C, MC, L, T, Z, and Bulb Angle Shapes

NOTE 1—Where “...” appears in this table, there is no requirement.

Nominal Size, ^A mm	Permitted Variations From Specified Length for Lengths Given in Metres, mm													
	1.5 to 3, excl		3 to 6, excl		6 to 9, incl		Over 9 to 12, incl		Over 12 to 15, incl		Over 15 to 20, incl		Over 20 m	
	Over	Under	Over	Under	Over	Under	Over	Under	Over	Under	Over	Under	Over	Under
Under 75	16	0	25	0	38	0	51	0	64	0	64	0
75 and over	25	0	38	0	45	0	57	0	70	0	70	0

^A Greatest cross-sectional dimension.

TABLE A1.20 Permitted Variations in End Out-of-Square for S, M, C, MC, L, T, Z, and Bulb Angle Shapes

Shapes	Permitted Variation
S, M, C, and MC	0.017 mm per millimetre of depth
L ^A	0.026 mm per millimetre of leg length or 1½ °
Bulb angles	0.026 mm per millimetre of depth or 1½ °
Rolled tees ^A	0.017 mm per millimetre of flange or stem
Zees	0.026 mm per millimetre of sum of both flange lengths

^A Permitted variations in ends out-of-square are determined on the longer members of the shape.

TABLE A1.21 Permitted Variations in Straightness for S, M, C, MC, L, T, Z, and Bulb Angle Shapes

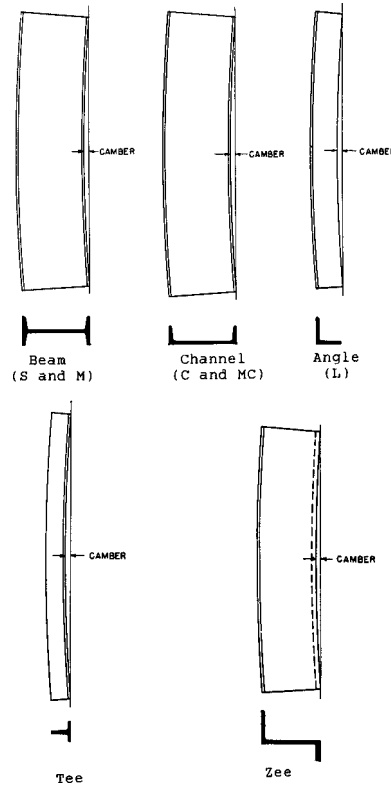

Positions for Measuring Camber of Shapes

Variable	Nominal Size, ^A mm	Permitted Variation, mm
Camber	Under 75	4 × number of metres of total length
	75 and over	2 × number of metres of total length
Sweep	All	Due to the extreme variations in flexibility of these shapes, permitted variations for sweep are subject to negotiations between the manufacturer and the purchaser for the individual sections involved.

^A Greatest cross-sectional dimension.

TABLE A1.22 Permitted Variations in Length for W and HP Shapes

W Shapes	Permitted Variations From Specified Length for Lengths Given in Metres, mm ^{A,B}			
	9 and Under		Over 9	
	Over	Under	Over	Under
Beams 610 mm and under in nominal depth	10	10	10 plus 1 for each additional 1 m or fraction thereof	10
Beams over 610 mm in nominal depth and all columns	13	13	13 plus 1 for each additional 1 m or fraction thereof	13

^A For HP and W shapes specified in the order for use as bearing piles, the permitted variations in length are plus 125 and minus 0 mm. These permitted variations in length also apply to sheet piles.

^B The permitted variations in end out-of-square for W and HP shapes shall be 0.016 mm per millimetre of depth, or per millimetre of flange width if the flange width is larger than the depth. The permitted variations shall be rounded to the nearest millimetre after calculation.

TABLE A1.23 Permitted Variations for Length and End Out-of-Square, Milled Shapes

Nominal Depth, mm	Length, ^B m	Permitted Variations in Length and End Out-of-Square, mm ^A					
		Milled Both Ends ^C			Milled One End ^C		
		Length		End Out-of-Square	Length		End Out-of-Square-(for Milled End)
Over	Under	Over	Under				
150 to 920	2 to 21	1	1	1	6	6	1

^A The permitted variations in length and end out-of-square are additive.

^B Length is measured along center line of web. Measurements are made with the steel and tape at the same temperature.

^C End out-of-square is measured by (a) squaring from the center line of the web and (b) squaring from the center line of the flange. The measured variation from true squareness in either plane shall not exceed the total tabular amount.

TABLE A1.24 Permitted Variations in Straightness for W and HP Shapes

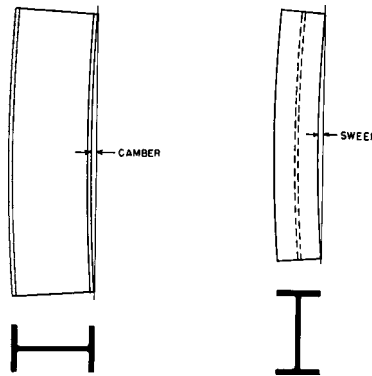

Positions for Measuring Camber and Sweep of W and HP Shapes

	Permitted Variation in Straightness, mm
Camber and sweep	$1 \times \text{number of metres of total length}^A$
When certain sections ^B with a flange width approximately equal to depth are specified in the order for use as columns:	
Lengths of 14 m and under	$1 \times \text{number of metres of total length, but not over 10}$
Lengths over 14 m	$10 + [1 \times (\text{number of metres of total length} - 14 \text{ m})]$

^A Sections with a flange width less than 150 mm, permitted variation for sweep, mm = $2 \times \text{number of metres of total length}$.

^B Applies only to:

- 200-mm deep sections—46.1 kg/m and heavier,
- 250-mm deep sections—73 kg/m and heavier,
- 310-mm deep sections—97 kg/m and heavier,
- 360-mm deep sections—116 kg/m and heavier,
- 410-mm deep sections—131 kg/m and heavier, and
- 460-mm deep sections—202 kg/m and heavier.

For other sections specified in the order for use as columns, the permitted variation is subject to negotiation with the manufacturer.

TABLE A1.25 Permitted Variations in Dimensions for Split Tees and Split Angles (L Shapes)^A

Specified Depth, mm	Permitted Variation Over or Under Specified Depth, ^B mm
To 150, excl (beams and channels)	3
150 to 410, excl (beams and channels)	5
410 to 510, excl (beams and channels)	6
510 to 610, excl (beams)	8
610 and over (beams)	10

^A The permitted variations in length for split tees or angles are the same as those applicable to the section from which the tees or angles are split.

^B The above permitted variations in depth of tees or angles include the permitted variations in depth for the beams or channels before splitting. Permitted variations in dimensions and straightness, as set up for the beams or channels from which these tees or angles are cut, apply, except

$$\text{straightness} = 2 \text{ mm} \times \text{length in metres}$$

TABLE A1.26 Permitted Variations in Sectional Dimensions for Square-Edge and Round-Edge Flat Bars

NOTE 1—Where “...” appears in this table, there is no requirement.

Specified Widths, mm	Permitted Variations Over or Under Specified Thickness, for Thicknesses Given in Millimetres, mm						Permitted Variations from Specified Width, mm	
	Over 5 to 6, incl	Over 6 to 12, incl	Over 12 to 25, incl	Over 25 to 50, incl	Over 50 to 75	Over 75	Over	Under
To 25, incl	0.18	0.20	0.25	0.5	0.5
Over 25 to 50, incl	0.18	0.30	0.40	0.8	1.0	1.0
Over 50 to 100, incl	0.20	0.40	0.50	0.8	1.2	1.2	1.5	1.0
Over 100 to 150, incl	0.25	0.40	0.50	0.8	1.2	1.2	2.5	1.5
Over 150 to 200, incl	^A	0.40	0.65	0.8	1.2	1.6	3.0	2.5

^A Flats over 150 to 200 mm, incl, in width are not available as hot-rolled bars in thickness 6 mm and under.

TABLE A1.27 Permitted Variations in Sectional Dimensions for Round and Square Bars and Round-Cornered Squares

NOTE 1—Where “...” appears in this table, there is no requirement.

Specified Sizes, mm	Permitted Variation Over or Under Specified Size		Permitted Out-of-Round or Out-of-Square Section ^A	
	mm	%	mm	%
	Up to 7.0, incl	0.13	...	0.20
Over 7.0 to 11.0, incl	0.15	...	0.22	...
Over 11.0 to 15.0, incl	0.18	...	0.27	...
Over 15.0 to 19.0, incl	0.20	...	0.30	...
Over 19.0 to 250, incl	...	1 ^B	...	1½ ^B

^A Out-of-round is the difference between the maximum and minimum diameters of the bar, measured at the same transverse cross section. Out-of-square section is the difference in perpendicular distance between opposite faces, measured at the same transverse cross section.

^B The permitted variation shall be rounded to the nearest tenth of a millimetre after calculation.

TABLE A1.28 Permitted Variations in Sectional Dimensions for Hexagons

Specified Sizes Between Opposite Sides, mm	Permitted Variations from Specified Size, mm		Out-of-Hexagon Section, mm ^A
	Over	Under	
To 13 incl	0.18	0.18	0.3
Over 13 to 25 incl	0.25	0.25	0.4
Over 25 to 40 incl	0.55	0.35	0.6
Over 40 to 50 incl	0.8	0.40	0.8
Over 50 to 65 incl	1.2	0.40	1.2
Over 65 to 80 incl	1.6	1.6	

^A Out-of-hexagon section is the greatest difference in distance between any two opposite faces, measured at the same transverse cross section.

TABLE A1.29 Permitted Variations in Straightness for Bars

Maximum Permitted Variation in Straightness, mm ^A
6 mm in any 1500 mm and (length in millimetres/250) ^B

^A Permitted variations in straightness do not apply to hot-rolled bars if any subsequent heating operation has been performed.

^B Round to the nearest whole millimetre.

TABLE A1.30 Permitted Variations in Length for Hot-Cut Steel Bars^A

NOTE 1—Where “...” appears in this table, there is no requirement.

Specified Sizes of Rounds, Squares, and Hexagons, mm	Specified Sizes of Flats, mm		Permitted Variations Over Specified Lengths Given in Metres, mm (No Variation Under)				
	Thickness	Width	1.5 to 3, excl	3 to 6, excl	6 to 9, excl	9 to 12, excl	12 to 18, incl
To 25, incl	to 25, incl	to 75, incl	15	20	35	45	60
Over 25 to 50, incl	over 25	to 75, incl	15	25	40	50	65
	to 25, incl	over 75 to 150, incl	15	25	40	50	65
Over 50 to 125, incl	over 25	over 75 to 150, incl	25	40	45	60	70
Over 125 to 250, incl	50	65	70	75	85
	over 6 to 25, incl	over 150 to 200, incl	20	30	45	90	100
	over 25 to 75, incl	over 150 to 200, incl	30	45	50	90	100
Bar size sections	15	25	40	50	65
Hot Sawing							
50 to 125, incl	25 and over	75 and over	^B	40	45	60	70
Over 125 to 250, incl	^B	65	70	75	85

^A For flats over 150 to 200 mm, incl, in width and over 75 mm in thickness, consult the manufacturer for permitted variations in length.

^B Smaller sizes and shorter lengths are not commonly hot sawed.

TABLE A1.31 Permitted Variations in Length for Bars Recut Both Ends After Straightening^{A,B}

Sizes of Rounds, Squares, Hexagons, Widths of Flats and Maximum Dimensions of Other Sections, mm	Permitted Variations Over Specified Length Given in Metres, mm (No Variation Under)	
	to 3.7, incl	over 3.7
To 75, incl	6	8
Over 75 to 150, incl	8	11
Over 150 to 200, incl	11	14
Rounds over 200 to 250, incl	14	18

^A For flats over 150 to 200 mm, incl, in width, and over 75 mm in thickness, consult the manufacturer or the processor for permitted variations in length.

^B Permitted variations are sometimes required all over or all under the specified length, in which case the sum of the two permitted variations applies.

A2. DIMENSIONS OF STANDARD SHAPE PROFILES

A2.1 Listed herein are dimensions and weight [mass] of some standard shape profiles. The values stated in inch-pound units are independent of the values stated in SI units, and the values from the two systems are not to be combined in any

way. Unless the order specifies the applicable “M” specification designation (SI units), the material shall be furnished to inch-pound units.

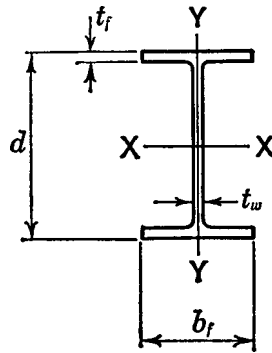
TABLE A2.1 “W” Shapes

Designation (Nominal Depth in Inches and Weight in Pounds per Linear Foot)	Area A , in. ²	Depth d , in.	Flange		Web Thickness t_w , in. ^A	Designation [Nominal Depth in Milli- metres and Mass in Kilo- grams per Metre]	Area A , mm ²	Depth d , mm	Flange		Web Thick- ness t_w , mm ^A
			Width b_f , in.	Thick- ness t_f , in. ^A					Width b_f , mm	Thick- ness, t_f , mm ^A	
W44 × 335	98.7	44.02	15.945	1.770	1.025	W1100 × 499	63 500	1 118	405	45.0	26.0
× 290	85.8	43.62	15.825	1.575	0.865	× 433	55 100	1 108	402	40.0	22.0
× 262	77.2	43.31	15.750	1.415	0.785	× 390	49 700	1 100	400	36.0	20.0
× 230	67.9	42.91	15.750	1.220	0.710	× 343	43 600	1 090	400	31.0	18.0
W40 × 593	174.4	42.99	16.690	3.230	1.790	W1000 × 883	112 500	1 092	424	82.0	45.5
× 503	147.8	42.05	16.415	2.755	1.535	× 748	95 300	1 068	417	70.0	39.0
× 431	126.7	41.26	16.220	2.360	1.340	× 642	81 800	1 048	412	60.0	34.0
× 397	117.0	40.95	16.120	2.200	1.220	× 591	75 300	1 040	409	55.9	31.0
× 372	109.4	40.63	16.065	2.045	1.160	× 554	70 600	1 032	408	52.0	29.5
× 362	107.0	40.55	16.020	2.010	1.120	× 539	68 700	1 030	407	51.1	28.4
× 324	95.3	40.16	15.910	1.810	1.000	× 483	61 500	1 020	404	46.0	25.4
× 297	87.4	39.84	15.825	1.650	0.930	× 443	56 400	1 012	402	41.9	23.6
× 277	81.3	39.69	15.830	1.575	0.830	× 412	52 500	1 008	402	40.0	21.1
× 249	73.3	39.38	15.750	1.420	0.750	× 371	47 300	1 000	400	36.1	19.0
× 215	63.3	38.98	15.750	1.220	0.650	× 321	40 800	990	400	31.0	16.5
× 199	58.4	38.67	15.750	1.065	0.650	× 296	37 700	982	400	27.1	16.5
W40 × 392	115.3	41.57	12.360	2.520	1.415	W1000 × 584	74 400	1 056	314	64.0	36.0
× 331	97.5	40.79	12.165	2.125	1.220	× 494	62 900	1 036	309	54.0	31.0
× 327	95.9	40.79	12.130	2.130	1.180	× 486	61 900	1 036	308	54.1	30.0
× 294	86.2	40.39	12.010	1.930	1.060	× 438	55 600	1 026	305	49.0	26.9
× 278	81.9	40.16	11.970	1.810	1.025	× 415	52 800	1 020	304	46.0	26.0
× 264	77.6	40.00	11.930	1.730	0.960	× 393	50 100	1 016	303	43.9	24.4
× 235	68.9	39.69	11.890	1.575	0.830	× 350	44 600	1 008	302	40.0	21.1
× 211	62.0	39.37	11.810	1.415	0.750	× 314	40 000	1 000	300	35.9	19.1
× 183	53.7	38.98	11.810	1.200	0.650	× 272	34 600	990	300	31.0	16.5
× 167	49.1	38.59	11.810	1.025	0.650	× 249	31 700	980	300	26.0	16.5
× 149	43.8	38.20	11.810	0.830	0.630	× 222	28 200	970	300	21.1	16.0
W36 × 652	191.7	41.05	17.575	3.540	1.970	W920 × 970	123 700	1 043	446	89.9	50.0
× 529	155.6	39.79	17.220	2.910	1.610	× 787	100 400	1 011	437	73.9	40.9
× 487	143.2	39.33	17.105	2.680	1.500	× 725	92 400	999	434	68.1	38.1
× 441	129.7	38.85	16.965	2.440	1.360	× 656	83 700	987	431	62.0	34.5
× 395	116.2	38.37	16.830	2.200	1.220	× 588	75 000	975	427	55.9	31.0
× 361	106.1	37.99	16.730	2.010	1.120	× 537	68 500	965	425	51.1	28.4
× 330	97.0	37.67	16.630	1.850	1.020	× 491	62 600	957	422	47.0	25.9
× 302	88.8	37.33	16.655	1.680	0.945	× 449	57 600	948	423	42.7	24.0
× 282	82.9	37.11	16.595	1.570	0.885	× 420	53 500	943	422	39.9	22.5

TABLE A2.1 *Continued*

Designation (Nominal Depth in Inches and Weight in Pounds per Linear Foot)	Area <i>A</i> , in. ²	Depth <i>d</i> , in.	Flange		Web Thickness <i>t_w</i> , in. ^A	Designation [Nominal Depth in Milli- metres and Mass in Kilo- grams per Metre]	Area <i>A</i> , mm ²	Depth <i>d</i> , mm	Flange		Web Thick- ness <i>t_w</i> , mm ^A
			Width <i>b_f</i> , in.	Thick- ness <i>t_f</i> , in. ^A					Width <i>b_f</i> , mm	Thick- ness, <i>t_f</i> , mm ^A	
× 262	77.0	36.85	16.550	1.440	0.840	× 390	49 700	936	420	36.6	21.3
× 247	72.5	36.67	16.510	1.350	0.800	× 368	46 800	931	419	34.3	20.3
× 231	68.0	36.49	16.470	1.260	0.760	× 344	43 900	927	418	32.0	19.3
W36 × 256	75.4	37.43	12.215	1.730	0.960	W920 × 381	48 600	951	310	43.9	24.4
× 232	68.1	37.12	12.120	1.570	0.870	× 345	44 000	943	308	39.9	22.1
× 210	61.8	36.69	12.180	1.360	0.830	× 313	39 900	932	309	34.5	21.1
× 194	57.0	36.49	12.115	1.260	0.765	× 289	36 800	927	308	32.0	19.4
× 182	53.6	36.33	12.075	1.180	0.725	× 271	34 600	923	307	30.0	18.4
× 170	50.0	36.17	12.030	1.100	0.680	× 253	32 300	919	306	27.9	17.3
× 160	47.0	36.01	12.000	1.020	0.650	× 238	30 300	915	305	25.9	16.5
× 150	44.2	35.85	11.975	0.940	0.625	× 223	28 500	911	304	23.9	15.9
× 135	39.7	35.55	11.950	0.790	0.600	× 201	25 600	903	304	20.1	15.2
W33 × 387	114.0	35.95	16.200	2.280	1.260	W840 × 576	73 500	913	411	57.9	32.0
× 354	104.1	35.55	16.100	2.090	1.160	× 527	67 200	903	409	53.1	29.5
× 318	93.5	35.16	15.985	1.890	1.040	× 473	60 300	893	406	48.0	26.4
× 291	85.6	34.84	15.905	1.730	0.960	× 433	55 200	885	404	43.9	24.4
× 263	77.4	34.53	15.805	1.570	0.870	× 392	49 900	877	401	39.9	22.1
× 241	70.9	34.18	15.860	1.400	0.830	× 359	45 700	868	403	35.6	21.1
× 221	65.0	33.93	15.805	1.275	0.775	× 329	41 900	862	401	32.4	19.7
× 201	59.1	33.68	15.745	1.150	0.715	× 299	38 100	855	400	29.2	18.2
W33 × 169	49.5	33.82	11.500	1.220	0.670	W840 × 251	31 900	859	292	31.0	17.0
× 152	44.7	33.49	11.565	1.055	0.635	× 226	28 800	851	294	26.8	16.1
× 141	41.6	33.30	11.535	0.960	0.605	× 210	26 800	846	293	24.4	15.4
× 130	38.3	33.09	11.510	0.855	0.580	× 193	24 700	840	292	21.7	14.7
× 118	34.7	32.86	11.480	0.740	0.550	× 176	22 400	835	292	18.8	14.0
W30 × 391	115.0	33.19	15.590	2.440	1.360	W760 × 582	74 200	843	396	62.0	34.5
× 357	104.8	32.80	15.470	2.240	1.240	× 531	67 600	833	393	56.9	31.5
× 326	95.7	32.40	15.370	2.050	1.140	× 484	61 700	823	390	52.1	29.0
× 292	85.7	32.01	15.255	1.850	1.020	× 434	55 300	813	387	47.0	25.9
× 261	76.7	31.61	15.155	1.650	0.930	× 389	49 500	803	385	41.9	23.6
× 235	69.0	31.30	15.055	1.500	0.830	× 350	44 500	795	382	38.1	21.1
× 211	62.0	30.94	15.105	1.315	0.775	× 314	40 000	786	384	33.4	19.7
× 191	56.1	30.68	15.040	1.185	0.710	X 284	36 200	779	382	30.1	18.0
× 173	50.8	30.44	14.985	1.065	0.655	X 257	32 800	773	381	27.1	16.6
W30 × 148	43.5	30.67	10.480	1.180	0.650	W760 × 220	28 100	779	266	30.0	16.5
× 132	38.9	30.31	10.545	1.000	0.615	× 196	25 100	770	268	25.4	15.6
× 124	36.5	30.17	10.515	0.930	0.585	× 185	23 500	766	267	23.6	14.9
× 116	34.2	30.01	10.495	0.850	0.565	× 173	22 100	762	267	21.6	14.4
× 108	31.7	29.83	10.475	0.760	0.545	× 161	20 500	758	266	19.3	13.8
× 99	29.1	29.65	10.450	0.670	0.520	× 147	18 800	753	265	17.0	13.2
× 90	26.4	29.53	10.400	0.610	0.470	× 134	17 000	750	264	15.5	11.9
W27 × 539	158.4	32.52	15.255	3.540	1.970	W690 × 802	102 200	826	387	89.9	50.0
× 368	108.1	30.39	14.665	2.480	1.380	× 548	69 800	772	372	63.0	35.1
× 336	98.7	30.0	14.550	2.280	1.260	× 500	63 700	762	369	57.9	32.0
× 307	90.2	29.61	14.445	2.090	1.160	× 457	58 200	752	367	53.1	29.5
× 281	82.6	29.29	14.350	1.930	1.060	× 419	53 300	744	364	49.0	26.9
× 258	75.7	28.98	14.270	1.770	0.980	× 384	48 900	736	362	45.0	24.9
× 235	69.1	28.66	14.190	1.610	0.910	× 350	44 600	728	360	40.9	23.1
× 217	63.8	28.43	14.115	1.500	0.830	× 323	41 100	722	359	38.1	21.1
× 194	57.0	28.11	14.035	1.340	0.750	× 289	36 800	714	356	34.0	19.0
× 178	52.3	27.81	14.085	1.190	0.725	× 265	33 700	706	358	30.2	18.4
× 161	47.4	27.59	14.020	1.080	0.660	× 240	30 600	701	356	27.4	16.8
× 146	42.9	27.38	13.965	0.975	0.605	× 217	27 700	695	355	24.8	15.4
W27 × 129	37.8	27.63	10.010	1.100	0.610	W690 × 192	24 400	702	254	27.9	15.5
× 114	33.5	27.29	10.070	0.930	0.570	× 170	21 600	693	256	23.6	14.5
× 102	30.0	27.09	10.015	0.830	0.515	× 152	19 400	688	254	21.1	13.1
× 94	27.7	26.92	9.990	0.745	0.490	× 140	17 900	684	254	18.9	12.4
× 84	24.8	26.71	9.960	0.640	0.460	× 125	16 000	678	253	16.3	11.7
W24 × 370	108.0	27.99	13.660	2.720	1.520	W610 × 551	70 200	711	347	69.1	38.6
× 335	98.4	27.52	13.520	2.480	1.380	× 498	63 500	699	343	63.0	35.1
× 306	89.8	27.13	13.405	2.280	1.260	× 455	57 900	689	340	57.9	32.0

TABLE A2.1 *Continued*

Designation (Nominal Depth in Inches and Weight in Pounds per Linear Foot)	Area A , in. ²	Depth d , in.	Flange		Web Thickness t_w , in. ⁴	Designation [Nominal Depth in Milli- metres and Mass in Kilo- grams per Metre]	Area A , mm ²	Depth d , mm	Flange		Web Thick- ness t_w , mm ⁴
			Width b_f , in.	Thick- ness t_f , in. ⁴					Width b_f , mm	Thick- ness, t_f , mm ⁴	
× 279	82.0	26.73	13.305	2.090	1.160	× 415	52 900	679	338	53.1	29.5
× 250	73.5	26.34	13.185	1.890	1.040	× 372	47 400	669	335	48.0	26.4
× 229	67.2	26.02	13.110	1.730	0.960	× 341	43 400	661	333	43.9	24.4
× 207	60.7	25.71	13.010	1.570	0.870	× 307	39 100	653	330	39.9	22.1
× 192	56.3	25.47	12.950	1.460	0.810	× 285	36 100	647	329	37.1	20.6
× 176	51.7	25.24	12.890	1.340	0.750	× 262	33 300	641	327	34.0	19.0
× 162	47.7	25.00	12.955	1.220	0.705	× 241	30 800	635	329	31.0	17.9
× 146	43.0	24.74	12.900	1.090	0.650	× 217	27 700	628	328	27.7	16.5
× 131	38.5	24.48	12.855	0.960	0.605	× 195	24 800	622	327	24.4	15.4
× 117	34.4	24.26	12.800	0.850	0.550	× 174	22 200	616	325	21.6	14.0
× 104	30.6	24.06	12.750	0.750	0.500	× 155	19 700	611	324	19.0	12.7
W24 × 103	30.3	24.53	9.000	0.980	0.550	W610 × 153	19 600	623	229	24.9	14.0
× 94	27.7	24.31	9.065	0.875	0.515	× 140	17 900	617	230	22.2	13.1
× 84	24.7	24.10	9.020	0.770	0.470	× 125	15 900	612	229	19.6	11.9
× 76	22.4	23.92	8.990	0.680	0.440	× 113	14 500	608	228	17.3	11.2
× 68	20.1	23.73	8.965	0.585	0.415	× 101	13 000	603	228	14.9	10.5
W24 × 62	18.2	23.74	7.040	0.590	0.430	W610 × 92	11 700	603	179	15.0	10.9
× 55	16.2	23.57	7.005	0.505	0.395	× 82	10 500	599	178	12.8	10.0
W21 × 201	59.2	23.03	12.575	1.630	0.910	W530 × 300	38 200	585	319	41.4	23.1
× 182	53.7	22.72	12.500	1.480	0.830	× 272	34 600	577	317	37.6	21.1
× 166	48.9	22.48	12.420	1.360	0.750	× 248	31 500	571	315	34.5	19.0
× 147	43.2	22.06	12.510	1.150	0.720	× 219	27 900	560	318	29.2	18.3
× 132	38.8	21.83	12.440	1.035	0.650	× 196	25 000	554	316	26.3	16.5
× 122	35.9	21.68	12.390	0.960	0.600	× 182	23 200	551	315	24.4	15.2
× 111	32.7	21.51	12.340	0.875	0.550	× 165	21 100	546	313	22.2	14.0
× 101	29.8	21.36	12.290	0.800	0.500	× 150	19 200	543	312	20.3	12.7
W21 × 93	27.3	21.62	8.420	0.930	0.580	W530 × 138	17 600	549	214	23.6	14.7
× 83	24.3	21.43	8.355	0.835	0.515	× 123	15 700	544	212	21.2	13.1
× 73	21.5	21.24	8.295	0.740	0.455	× 109	13 900	539	211	18.8	11.6
× 68	20.0	21.13	8.270	0.685	0.430	× 101	12 900	537	210	17.4	10.9
× 62	18.3	20.99	8.240	0.615	0.400	× 92	11 800	533	209	15.6	10.2
× 55	16.2	20.80	8.220	0.522	0.375	× 82	10 500	528	209	13.3	9.50
× 48	14.1	20.62	8.140	0.430	0.350	× 72	9 180	524	207	10.9	9.00
W21 × 57	16.7	21.06	6.555	0.650	0.405	W530 × 85	10 800	535	166	16.5	10.3
× 50	14.7	20.83	6.530	0.535	0.380	× 74	9 480	529	166	13.6	9.7
× 44	13.0	20.66	6.500	0.450	0.350	× 66	8 390	525	165	11.4	8.9
W18 × 311	91.5	22.32	12.005	2.740	1.520	W460 × 464	59 100	567	305	69.6	38.6
× 283	83.2	21.85	11.890	2.500	1.400	× 421	53 700	555	302	63.5	35.6
× 258	75.9	21.46	11.770	2.300	1.280	× 384	49 000	545	299	58.4	32.5
× 234	68.8	21.06	11.650	2.110	1.160	× 349	44 400	535	296	53.6	29.5
× 211	62.1	20.67	11.555	1.910	1.060	× 315	40 100	525	293	48.5	26.9
× 192	56.4	20.35	11.455	1.750	0.960	× 286	36 400	517	291	44.4	24.4
× 175	51.3	20.04	11.375	1.590	0.890	× 260	33 100	509	289	40.4	22.6
× 158	46.3	19.72	11.300	1.440	0.810	× 235	29 900	501	287	36.6	20.6
× 143	42.1	19.49	11.220	1.320	0.730	× 213	27 100	495	285	33.5	18.5
× 130	38.2	19.25	11.160	1.200	0.670	× 193	24 700	489	283	30.5	17.0
× 119	35.1	18.97	11.265	1.060	0.655	× 177	22 600	482	286	26.9	16.6
× 106	31.1	18.73	11.200	0.940	0.590	× 158	20 100	476	284	23.9	15.0
× 97	28.5	18.59	11.145	0.870	0.535	× 144	18 400	472	283	22.1	13.6
× 86	25.3	18.39	11.090	0.770	0.480	× 128	16 300	467	282	19.6	12.2
× 76	22.3	18.21	11.035	0.680	0.425	× 113	14 400	463	280	17.3	10.8
W18 × 71	20.8	18.47	7.635	0.810	0.495	W460 × 106	13 400	469	194	20.6	12.6
× 65	19.1	18.35	7.590	0.750	0.450	× 97	12 300	466	193	19.0	11.4
× 60	17.6	18.24	7.555	0.695	0.415	× 89	11 400	463	192	17.7	10.5
× 55	16.2	18.11	7.530	0.630	0.390	× 82	10 500	460	191	16.0	9.9
× 50	14.7	17.99	7.495	0.570	0.355	× 74	9 480	457	190	14.5	9.0
W18 × 46	13.5	18.06	6.060	0.605	0.360	W460 × 68	8 710	459	154	15.4	9.1
× 40	11.8	17.90	6.015	0.525	0.315	× 60	7 610	455	153	13.3	8.0
× 35	10.3	17.70	6.000	0.425	0.300	× 52	6 650	450	152	10.8	7.6
W16 × 100	29.4	16.97	10.425	0.985	0.585	W410 × 149	19 000	431	265	25.0	14.9

TABLE A2.1 *Continued*

Designation (Nominal Depth in Inches and Weight in Pounds per Linear Foot)	Area A , in. ²	Depth d , in.	Flange		Web Thickness t_w , in. ⁴	Designation [Nominal Depth in Milli- metres and Mass in Kilo- grams per Metre]	Area A , mm ²	Depth d , mm	Flange		Web Thick- ness t_w , mm ⁴
			Width b_f , in.	Thick- ness t_f , in. ⁴					Width b_f , mm	Thick- ness, t_f , mm ⁴	
× 89	26.2	16.75	10.365	0.875	0.525	× 132	16 900	425	263	22.2	13.3
× 77	22.6	16.52	10.295	0.760	0.455	× 114	14 600	420	261	19.3	11.6
× 67	19.7	16.33	10.235	0.665	0.395	× 100	12 700	415	260	16.9	10.0
W16 × 57	16.8	16.43	7.120	0.715	0.430	W410 × 85	10 800	417	181	18.2	10.9
× 50	14.7	16.26	7.070	0.630	0.380	× 75	9 480	413	180	16.0	9.7
× 45	13.3	16.13	7.035	0.565	0.345	× 67	8 580	410	179	14.4	8.8
× 40	11.8	16.01	6.995	0.505	0.305	× 60	7 610	407	178	12.8	7.7
× 36	10.6	15.86	6.985	0.430	0.295	× 53	6 840	403	177	10.9	7.5
W16 × 31	9.12	15.88	5.525	0.440	0.275	W410 × 46.1	5 880	403	140	11.2	7.0
× 26	7.68	15.69	5.500	0.345	0.250	× 38.8	4 950	399	140	8.8	6.4
W14 × 730	215.0	22.42	17.890	4.910	3.070	W360 × 1086	139 000	569	454	125.0	78.0
× 665	196.0	21.64	17.650	4.520	2.830	× 990	126 000	550	448	115.0	71.9
× 605	178.0	20.92	17.415	4.160	2.595	× 900	115 000	531	442	106.0	65.9
× 550	162.0	20.24	17.200	3.820	2.380	× 818	105 000	514	437	97.0	60.5
× 500	147.0	19.60	17.010	3.500	2.190	× 744	94 800	498	432	88.9	55.6
× 455	134.0	19.02	16.835	3.210	2.015	× 677	86 500	483	428	81.5	51.2
× 426	125.0	18.67	16.695	3.035	1.875	× 634	80 600	474	424	77.1	47.6
× 398	117.0	18.29	16.590	2.845	1.770	× 592	75 500	465	421	72.3	45.0
× 370	109.0	17.92	16.475	2.660	1.655	× 551	70 300	455	418	67.6	42.0
× 342	101.0	17.54	16.360	2.470	1.540	× 509	65 200	446	416	62.7	39.1
× 311	91.4	17.12	16.230	2.260	1.410	× 463	59 000	435	412	57.4	35.8
× 283	83.3	16.74	16.110	2.070	1.290	× 421	53 700	425	409	52.6	32.8
× 257	75.6	16.38	15.995	1.890	1.175	× 382	48 800	416	406	48.0	29.8
× 233	68.5	16.04	15.890	1.720	1.070	× 347	44 200	407	404	43.7	27.2
× 211	62.0	15.72	15.800	1.560	0.980	× 314	40 000	399	401	39.6	24.9
× 193	56.8	15.48	15.710	1.440	0.890	× 287	36 600	393	399	36.6	22.6
× 176	51.8	15.22	15.650	1.310	0.830	× 262	33 400	387	398	33.3	21.1
× 159	46.7	14.98	15.565	1.190	0.745	× 237	30 100	380	395	30.2	18.9
× 145	42.7	14.78	15.500	1.090	0.680	× 216	27 500	375	394	27.7	17.3
W14 × 132	38.8	14.66	14.725	1.030	0.645	W360 × 196	25 000	372	374	26.2	16.4
× 120	35.3	14.48	14.670	0.940	0.590	× 179	22 800	368	373	23.9	15.0
× 109	32.0	14.32	14.605	0.860	0.525	× 162	20 600	364	371	21.8	13.3
× 99	29.1	14.16	14.565	0.780	0.485	× 147	18 800	360	370	19.8	12.3
× 90	26.5	14.02	14.520	0.710	0.440	× 134	17 100	356	369	18.0	11.2
W14 × 82	24.1	14.31	10.130	0.855	0.510	W360 × 122	15 500	363	257	21.7	13.0
× 74	21.8	14.17	10.070	0.785	0.450	× 110	14 100	360	256	19.9	11.4
× 68	20.0	14.04	10.035	0.720	0.415	× 101	12 900	357	255	18.3	10.5
× 61	17.9	13.89	9.995	0.645	0.375	× 91	11 500	353	254	16.4	9.5
W14 × 53	15.6	13.92	8.060	0.660	0.370	W360 × 79	10 100	354	205	16.8	9.4
× 48	14.1	13.79	8.030	0.595	0.340	× 72	9 100	350	204	15.1	8.6
× 43	12.6	13.66	7.995	0.530	0.305	× 64	8 130	347	203	13.5	7.7
W14 × 38	11.2	14.10	6.770	0.515	0.310	W360 × 58	7 230	358	172	13.1	7.9
× 34	10.0	13.98	6.745	0.455	0.285	× 51	6 450	355	171	11.6	7.2
× 30	8.85	13.84	6.730	0.385	0.270	× 44.6	5 710	352	171	9.8	6.9
W14 × 26	7.69	13.91	5.025	0.420	0.255	W360 × 39.0	4 960	353	128	10.7	6.5
× 22	6.49	13.74	5.000	0.335	0.230	× 32.9	4 190	349	127	8.5	5.8
W12 × 336	98.8	16.82	13.385	2.955	1.775	W310 × 500	63 700	427	340	75.1	45.1
× 305	89.6	16.32	13.235	2.705	1.625	× 454	57 800	415	336	68.7	41.3
× 279	81.9	15.85	13.140	2.470	1.530	× 415	52 800	403	334	62.7	38.9
× 252	74.1	15.41	13.005	2.250	1.395	× 375	47 800	391	330	57.2	35.4
× 230	67.7	15.05	12.895	2.070	1.285	× 342	43 700	382	328	52.6	32.6
× 210	61.8	14.71	12.790	1.900	1.180	× 313	39 900	374	325	48.3	30.0
× 190	55.8	14.38	12.670	1.735	1.060	× 283	36 000	365	322	44.1	26.9
× 170	50.0	14.03	12.570	1.560	0.960	× 253	32 300	356	319	39.6	24.4
× 152	44.7	13.71	12.480	1.400	0.870	× 226	28 800	348	317	35.6	22.1
× 136	39.9	13.41	12.400	1.250	0.790	× 202	25 700	341	315	31.8	20.1
× 120	35.3	13.12	12.320	1.105	0.710	× 179	22 800	333	313	28.1	18.0
× 106	31.2	12.89	12.220	0.990	0.610	× 158	20 100	327	310	25.1	15.5
× 96	28.2	12.71	12.160	0.900	0.550	× 143	18 200	323	309	22.9	14.0
× 87	25.6	12.53	12.125	0.810	0.515	× 129	16 500	318	308	20.6	13.1

TABLE A2.1 *Continued*

Designation (Nominal Depth in Inches and Weight in Pounds per Linear Foot)	Area <i>A</i> , in. ²	Depth <i>d</i> , in.	Flange		Web Thickness <i>t_w</i> , in. ⁴	Designation [Nominal Depth in Milli- metres and Mass in Kilo- grams per Metre]	Area <i>A</i> , mm ²	Depth <i>d</i> , mm	Flange		Web Thick- ness <i>t_w</i> , mm ⁴
			Width <i>b_f</i> , in.	Thick- ness <i>t_f</i> , in. ⁴					Width <i>b_f</i> , mm	Thick- ness, <i>t_f</i> , mm ⁴	
× 79	23.2	12.38	12.080	0.735	0.470	× 117	15 000	314	307	18.7	11.9
× 72	21.1	12.25	12.040	0.670	0.430	× 107	13 600	311	306	17.0	10.9
× 65	19.1	12.12	12.000	0.605	0.390	× 97	12 300	308	305	15.4	9.9
W12 × 58	17.0	12.19	10.010	0.640	0.360	W310 × 86	11 000	310	254	16.3	9.1
× 53	15.6	12.06	9.995	0.575	0.345	× 79	10 100	306	254	14.6	8.8
W12 × 50	14.7	12.19	8.080	0.640	0.370	W310 × 74	9 480	310	205	16.3	9.4
× 45	13.2	12.06	8.045	0.575	0.335	× 67	8 520	306	204	14.6	8.5
× 40	11.8	11.94	8.005	0.515	0.295	× 60	7 610	303	203	13.1	7.5
W12 × 35	10.3	12.50	6.560	0.520	0.300	W310 × 52	6 650	317	167	13.2	7.6
× 30	8.79	12.34	6.520	0.440	0.260	× 44.5	5 670	313	166	11.2	6.6
× 26	7.65	12.22	6.490	0.380	0.230	× 38.7	4 940	310	165	9.7	5.8
W12 × 22	6.48	12.31	4.030	0.425	0.260	W310 × 32.7	4 180	313	102	10.8	6.6
× 19	5.57	12.16	4.005	0.350	0.235	× 28.3	3 590	309	102	8.9	6.0
× 16	4.71	11.99	3.990	0.265	0.220	× 23.8	3 040	305	101	6.7	5.6
× 14	4.16	11.91	3.970	0.225	0.200	× 21.0	2 680	303	101	5.7	5.1
W10 × 112	32.9	11.36	10.415	1.250	0.755	W250 × 167	21 200	289	265	31.8	19.2
× 100	29.4	11.10	10.340	1.120	0.680	× 149	19 000	282	263	28.4	17.3
× 88	25.9	10.84	10.265	0.990	0.605	× 131	16 700	275	261	25.1	15.4
× 77	22.6	10.60	10.190	0.870	0.530	× 115	14 600	269	259	22.1	13.5
× 68	20.0	10.40	10.130	0.770	0.470	× 101	12 900	264	257	19.6	11.9
× 60	17.6	10.22	10.080	0.680	0.420	× 89	11 400	260	256	17.3	10.7
× 54	15.8	10.09	10.030	0.615	0.370	× 80	10 200	256	255	15.6	9.4
× 49	14.4	9.98	10.000	0.560	0.340	× 73	9 290	253	254	14.2	8.6
W10 × 45	13.3	10.10	8.020	0.620	0.350	W250 × 67	8 580	257	204	15.7	8.9
× 39	11.5	9.92	7.985	0.530	0.315	× 58	7 420	252	203	13.5	8.0
× 33	9.71	9.73	7.960	0.435	0.290	× 49.1	6 260	247	202	11.0	7.4
W10 × 30	8.84	10.47	5.810	0.510	0.300	W250 × 44.8	5 700	266	148	13.0	7.6
× 26	7.61	10.33	5.770	0.440	0.260	× 38.5	4 910	262	147	11.2	6.6
× 22	6.49	10.17	5.750	0.360	0.240	× 32.7	4 190	258	146	9.1	6.1
W10 × 19	5.62	10.24	4.020	0.395	0.250	W250 × 28.4	3 630	260	102	10.0	6.4
× 17	4.99	10.11	4.010	0.330	0.240	× 25.3	3 220	257	102	8.4	6.1
× 15	4.41	9.99	4.000	0.270	0.230	× 22.3	2 850	254	102	6.9	5.8
× 12	3.54	9.87	3.960	0.210	0.190	× 17.9	2 280	251	101	5.3	4.8
W8 × 67	19.7	9.00	8.280	0.935	0.570	W200 × 100	12 700	229	210	23.7	14.5
× 58	17.1	8.75	8.220	0.810	0.510	× 86	11 000	222	209	20.6	13.0
× 48	14.1	8.50	8.110	0.685	0.400	× 71	9 100	216	206	17.4	10.2
× 40	11.7	8.25	8.070	0.560	0.360	× 59	7 550	210	205	14.2	9.1
× 35	10.3	8.12	8.020	0.495	0.310	× 52	6 650	206	204	12.6	7.9
× 31	9.13	8.00	7.995	0.435	0.285	× 46.1	5 890	203	203	11.0	7.2
W8 × 28	8.25	8.06	6.535	0.465	0.285	W200 × 41.7	5 320	205	166	11.8	7.2
× 24	7.08	7.93	6.495	0.400	0.245	× 35.9	4 570	201	165	10.2	6.2
W8 × 21	6.16	8.28	5.270	0.400	0.250	W200 × 31.3	3 970	210	134	10.2	6.4
× 18	5.26	8.14	5.250	0.330	0.230	× 26.6	3 390	207	133	8.4	5.8
W8 × 15	4.44	8.11	4.015	0.315	0.245	W200 × 22.5	2 860	206	102	8.0	6.2
× 13	3.84	7.99	4.000	0.255	0.230	× 19.3	2 480	203	102	6.5	5.8
× 10	2.96	7.89	3.940	0.205	0.170	× 15.0	1 910	200	100	5.2	4.3
W6 × 25	7.34	6.38	6.080	0.455	0.320	W150 × 37.1	4 740	162	154	11.6	8.1
× 20	5.87	6.20	6.020	0.365	0.260	× 29.8	3 790	157	153	9.3	6.6
× 15	4.43	5.99	5.990	0.260	0.230	× 22.5	2 860	152	152	6.6	5.8
W6 × 16	4.74	6.28	4.030	0.405	0.260	W150 × 24.0	3 060	160	102	10.3	6.6
× 12	3.55	6.03	4.000	0.280	0.230	× 18.0	2 290	153	102	7.1	5.8
× 9	2.68	5.90	3.940	0.215	0.170	× 13.5	1 730	150	100	5.5	4.3
× 8.5	2.52	5.83	3.940	0.195	0.170	× 13.0	1 630	148	100	4.9	4.3
W5 × 19	5.54	5.15	5.030	0.430	0.270	W130 × 28.1	3 590	131	128	10.9	6.9

TABLE A2.1 *Continued*

Designation (Nominal Depth in Inches and Weight in Pounds per Linear Foot)	Area A , in. ²	Depth d , in.	Flange		Web Thickness t_w , in. ^A	Designation [Nominal Depth in Milli- metres and Mass in Kilo- grams per Metre]	Area A , mm ²	Depth d , mm	Flange		Web Thick- ness t_w , mm ^A
			Width b_f , in.	Thick- ness t_f , in. ^A					Width b_f , mm	Thick- ness, t_f , mm ^A	
× 16	4.68	5.01	5.000	0.360	0.240	× 23.8	3 040	127	127	9.1	6.1
W4 × 13	3.83	4.16	4.060	0.345	0.280	W100 × 19.3	2 470	106	103	8.8	7.1

^A Actual flange and web thicknesses vary due to mill rolling practices; however, permitted variations for such dimensions are not addressed.

TABLE A2.2 "S" Shapes

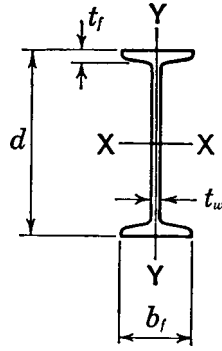

Designation (Nominal Depth in Inches and Weight in Pounds per Linear Foot)	Area <i>A</i> , in. ²	Depth <i>d</i> , in.	Flange		Web Thick- ness <i>t_w</i> , in. ⁴	Designation [Nominal Depth in Milli- metres and Mass in Kilo- grams per Metre]	Area <i>A</i> , mm ²	Depth <i>d</i> , mm	Flange		Web Thick- ness <i>t_w</i> , mm ⁴
			Width <i>b_f</i> , in.	Thick- ness <i>t_f</i> , in. ⁴					Width <i>b_f</i> , mm	Thick- ness, <i>t_f</i> , mm ⁴	
S 24 × 121 × 106	35.6 31.2	24.50 24.50	8.050 7.870	1.090 1.090	0.800 0.620	S 610 × 180 × 158	23 000 20 100	622 622	204 200	27.7 27.7	20.3 15.7
S 24 × 100 × 90 × 80	29.3 26.5 23.5	24.00 24.00 24.00	7.245 7.125 7.000	0.870 0.870 0.870	0.745 0.625 0.500	S 610 × 149 × 134 × 119	18 900 17 100 15 200	610 610 610	184 181 178	22.1 22.1 22.1	18.9 15.9 12.7
S 20 × 96 × 86	28.2 25.3	20.30 20.30	7.200 7.060	0.920 0.920	0.800 0.660	S 510 × 143 × 128	18 200 16 300	516 516	183 179	23.4 23.4	20.3 16.8
S 20 × 75 × 66	22.0 19.4	20.00 20.00	6.385 6.255	0.795 0.795	0.635 0.505	S 510 × 112 × 98	14 200 12 500	508 508	162 159	20.2 20.2	16.1 12.8
S 18 × 70 × 54.7	20.6 16.1	18.00 18.00	6.251 6.001	0.691 0.691	0.711 0.461	S 460 × 104 × 81.4	13 300 10 400	457 457	159 152	17.6 17.6	18.1 11.7
S 15 × 50 × 42.9	14.7 12.6	15.00 15.00	5.640 5.501	0.622 0.622	0.550 0.411	S 380 × 74 × 64	9 480 8 130	381 381	143 140	15.8 15.8	14.0 10.4
S 12 × 50 × 40.8	14.7 12.0	12.00 12.00	5.477 5.252	0.659 0.659	0.687 0.462	S 310 × 74 × 60.7	9 480 7 740	305 305	139 133	16.7 16.7	17.4 11.7
S 12 × 35 × 31.8	10.3 9.35	12.00 12.00	5.078 5.000	0.544 0.544	0.428 0.350	S 310 × 52 × 47.3	6 650 6 030	305 305	129 127	13.8 13.8	10.9 8.9
S 10 × 35 × 25.4	10.3 7.46	10.00 10.00	4.944 4.661	0.491 0.491	0.594 0.311	S 250 × 52 × 37.8	6 650 4 810	254 254	126 118	12.5 12.5	15.1 7.9
S 8 × 23 × 18.4	6.77 5.41	8.00 8.00	4.171 4.001	0.425 0.425	0.441 0.271	S 200 × 34 × 27.4	4 370 3 480	203 203	106 102	10.8 10.8	11.2 6.9
S 6 × 17.25 × 12.5	5.07 3.67	6.00 6.00	3.565 3.332	0.359 0.359	0.465 0.232	S 150 × 25.7 × 18.6	3 270 2 360	152 152	91 85	9.1 9.1	11.8 5.9
S 5 × 10	2.94	5.00	3.004	0.326	0.214	S 130 × 15	1 880	127	76	8.3	5.4
S 4 × 9.5 × 7.7	2.79 2.26	4.00 4.00	2.796 2.663	0.293 0.293	0.326 0.193	S 100 × 14.1 × 11.5	1 800 1 450	102 102	71 68	7.4 7.4	8.3 4.9
S 3 × 7.5 × 5.7	2.21 1.67	3.00 3.00	2.509 2.330	0.260 0.260	0.349 0.170	S 75 × 11.2 × 8.5	1 430 1 080	76 76	64 59	6.6 6.6	8.9 4.3

⁴ Actual flange and web thicknesses vary due to mill rolling practices; however, permitted variations for such dimensions are not addressed.

TABLE A2.3 “M” Shapes

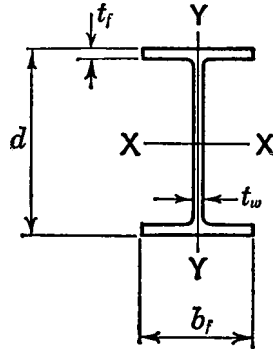

Designation (Nominal Depth in Inches and Weight in Pounds per Linear Foot)	Area A , in. ²	Depth d , in.	Flange		Web Thick- ness t_w , in. ⁴	Designation [Nominal Depth in Milli- metres and Mass in Kilo- grams per Metre]	Area A , mm ²	Depth d , mm	Flange		Web Thick- ness t_w , mm ⁴
			Width b_f , in.	Thick- ness t_f , in. ⁴					Width b_f , mm	Thick- ness, t_f , mm ⁴	
M 12.5 × 12.4 × 11.6	3.66	12.534	3.750	0.228	0.155	M 318 × 18.5 × 17.3	2 361	318	95	5.8	3.9
	3.43	12.500	3.500	0.211	0.155		2 213	317	89	5.4	3.9
M 12 × 11.8 × 10.8 × 10.0	3.47	12.00	3.065	0.225	0.177	M 310 × 17.6 × 16.1 × 14.9	2 240	305	78	5.7	4.5
	3.18	11.97	3.065	0.210	0.160		2 050	304	78	5.3	4.1
	2.94	11.97	3.250	0.180	0.149		1 900	304	83	4.6	3.8
M 10 × 9.0 × 8.0 × 7.5	2.65	10.00	2.690	0.206	0.157	M 250 × 13.4 × 11.9 × 11.2	1 710	254	68	4.6	3.6
	2.35	9.95	2.690	0.182	0.141		1 520	253	68	5.2	4.0
	2.21	9.99	2.688	0.173	0.130		1 430	253	68	4.4	3.3
M 8 × 6.5 × 6.2	1.92	8.00	2.281	0.189	0.135	M 200 × 9.7 × 9.2	1 240	203	57	4.8	3.4
	1.81	8.00	2.281	0.177	0.129		1 170	203	58	4.5	3.3
M 6 × 4.4 × 3.7	1.29	6.00	1.844	0.171	0.114	M 150 × 6.6 × 5.5	832	152	47	4.3	2.9
	1.09	5.92	2.000	0.129	0.098		703	150	51	3.3	2.5
M 5 × 18.9	5.55	5.00	5.003	0.416	0.316	M 130 × 28.1	3 580	127	127	10.6	8.0
M 4 × 6.0 × 4.08 × 3.45 × 3.2	1.78	3.80	3.80	0.160	0.130	M 100 × 8.9 × 6.1 × 5.1 × 4.8	1 150	97	97	4.1	3.3
	1.20	4.00	2.250	0.170	0.115		775	102	57	4.3	2.9
	1.02	4.00	2.250	0.130	0.092		665	102	57	3.3	2.8
	0.94	4.00	2.250	0.130	0.092		610	102	57	3.3	2.3
M 3 × 2.9	0.853	3.00	2.250	0.130	0.090	M 75 × 4.3	550	76	57	3.3	2.3

^A Actual flange and web thicknesses vary due to mill rolling practices; however, permitted variations for such dimensions are not addressed.

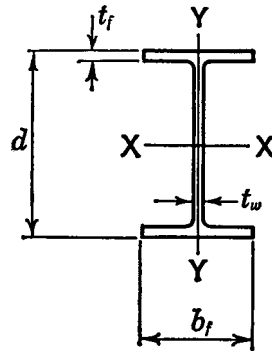
TABLE A2.4 “HP” Shapes

Designation (Nominal Depth in Inches and Weight in Pounds per Linear Foot)	Area A , in. ²	Depth d , in.	Flange		Web Thick- ness t_w , in. ⁴	Designation [Nominal Depth in Milli- metres and Mass in Kilo- grams per Metre]	Area A , mm ²	Depth d , mm	Flange		Web Thick- ness t_w , mm ⁴
			Width b_f , in.	Thick- ness t_f , in. ⁴					Width b_f , mm	Thickness, t_f , mm ⁴	
HP18 × 204	60.0	18.25	18.125	1.125	1.125	HP460 × 304	38 700	464	460	28.6	28.6
× 181	53.2	18.00	18.000	1.000	1.000	× 267	34 300	457	457	25.4	25.4
× 157	46.2	17.74	17.870	0.870	0.870	× 234	29 800	451	454	22.1	22.1
× 135	39.8	17.50	17.750	0.750	0.750	× 202	25 700	445	451	19.1	19.1
HP16 × 183	53.8	16.50	16.250	1.125	1.125	HP410 × 272	34 700	419	413	29.6	29.6
× 162	47.7	16.25	16.125	1.000	1.000	× 242	30 800	413	410	25.4	25.4
× 141	41.7	16.00	16.000	0.875	0.875	× 211	26 900	406	406	22.2	22.2
× 121	25.7	15.75	15.875	0.875	0.875	× 181	23 000	400	403	19.1	19.1
× 101	29.8	15.50	15.750	0.625	0.625	× 151	19 200	394	400	15.9	15.9
× 88	25.8	15.33	15.665	0.540	0.540	× 131	16 700	389	198	13.7	13.7
HP14 × 117	34.4	14.21	14.885	0.805	0.805	HP360 × 174	22 200	361	378	20.4	20.4
× 102	30.0	14.01	14.785	0.705	0.705	× 152	19 400	356	376	17.9	17.9
× 89	26.1	13.83	14.695	0.615	0.615	× 132	16 800	351	373	15.6	15.6
× 73	21.4	13.61	14.585	0.505	0.505	× 108	13 800	346	370	12.8	12.8
HP12 × 84	24.6	12.28	12.295	0.685	0.685	HP310 × 125	15 900	312	312	17.4	17.4
× 74	21.8	12.13	12.215	0.610	0.605	× 110	14 100	308	310	15.5	15.4
× 63	18.4	11.94	12.125	0.515	0.515	× 93	11 900	303	308	13.1	13.1
× 53	15.5	11.78	12.045	0.435	0.435	× 79	10 000	299	306	11.0	11.0
HP10 × 57	16.8	9.99	10.225	0.565	0.565	HP250 × 85	10 800	254	260	14.4	14.4
× 42	12.4	9.70	10.075	0.420	0.415	× 62	8 000	246	256	10.7	10.5
HP8 × 36	10.6	8.02	8.155	0.445	0.445	HP200 × 53	6 840	204	207	11.3	11.3

⁴ Actual flange and web thicknesses vary due to mill rolling practices; however, permitted variations for such dimensions are not addressed.

TABLE A2.5 “C” Shapes

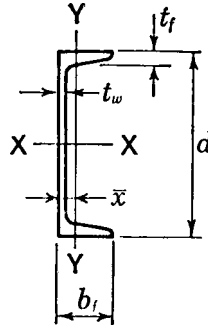

Designation (Nominal Depth in Inches and Weight in Pounds per Linear Foot)	Area A , in. ²	Depth d , in.	Flange		Web Thick- ness t_w , in. ⁴	Designation [Nominal Depth in Milli- metres in Mass in Kilograms per Metre]	Area A , mm ²	Depth d , mm	Flange		Web Thick- ness t_w , mm ⁴
			Width b_f , in.	Thick- ness t_f , in. ⁴					Width b_f , mm	Thick- ness t_f , mm ⁴	
C 15 × 50	14.7	15.00	3.716	0.650	0.716	C 380 × 74	9 480	381	94	16.5	18.2
× 40	11.8	15.00	3.520	0.650	0.520	× 60	7 610	381	89	16.5	13.2
× 33.9	9.96	15.00	3.400	0.650	0.400	× 50.4	6 430	381	86	16.5	10.2
C 12 × 30	8.82	12.00	3.170	0.501	0.510	C 310 × 45	5 690	305	80	12.7	13.0
× 25	7.35	12.00	3.047	0.501	0.387	× 37	4 740	305	77	12.7	9.8
× 20.7	6.09	12.00	2.942	0.501	0.282	× 30.8	3 930	305	74	12.7	7.2
C 10 × 30	8.82	10.00	3.033	0.436	0.673	C 250 × 45	5 690	254	76	11.1	17.1
× 25	7.35	10.00	2.886	0.436	0.526	× 37	4 740	254	73	11.1	13.4
× 20	5.88	10.00	2.739	0.436	0.379	× 30	3 790	254	69	11.1	9.6
× 15.3	4.49	10.00	2.600	0.436	0.240	× 22.8	2 900	254	65	11.1	6.1
C 9 × 20	5.88	9.00	2.648	0.413	0.448	C 230 × 30	3 790	229	67	10.5	11.4
× 15	4.41	9.00	2.485	0.413	0.285	× 22	2 850	229	63	10.5	7.2
× 13.4	3.94	9.00	2.433	0.413	0.233	× 19.9	2 540	229	61	10.5	5.9
C 8 × 18.75	5.51	8.00	2.527	0.390	0.487	C 200 × 27.9	3 550	203	64	9.9	12.4
× 13.75	4.04	8.00	2.343	0.390	0.303	× 20.5	2 610	203	59	9.9	7.7
× 11.5	3.38	8.00	2.260	0.390	0.220	× 17.1	2 180	203	57	9.9	5.6
C 7 × 14.75	4.33	7.00	2.299	0.366	0.419	C 180 × 22	2 790	178	58	9.3	10.6
× 12.25	3.60	7.00	2.194	0.366	0.314	× 18.2	2 320	178	55	9.3	8.0
× 9.8	2.87	7.00	2.090	0.366	0.210	× 14.6	1 850	178	53	9.3	5.3
C 6 × 13	3.83	6.00	2.157	0.343	0.437	C 150 × 19.3	2 470	152	54	8.7	11.1
× 10.5	3.09	6.00	2.034	0.343	0.314	× 15.6	1 990	152	51	8.7	8.0
× 8.2	2.40	6.00	1.920	0.343	0.200	× 12.2	1 550	152	48	8.7	5.1
C 5 × 9	2.64	5.00	1.885	0.320	0.325	C 130 × 13	1 700	127	47	8.1	8.3
× 6.7	1.97	5.00	1.750	0.320	0.190	× 10.4	1 270	127	44	8.1	4.8
C 4 × 7.25	2.13	4.00	1.721	0.296	0.321	C 100 × 10.8	1 370	102	43	7.5	8.2
× 6.25	1.84	4.00	1.647	0.272	0.247	× 9.3	1 187	102	42	6.9	6.3
× 5.4	1.59	4.00	1.584	0.296	0.184	× 8	1 030	102	40	7.5	4.7
× 4.5	1.32	4.00	1.584	0.296	0.125	× 6.7	852	102	40	7.5	3.2
C 3 × 6	1.76	3.00	1.596	0.273	0.356	C 75 × 8.9	1 130	76	40	6.9	9.0
× 5	1.47	3.00	1.498	0.273	0.258	× 7.4	948	76	37	6.9	6.6
× 4.1	1.21	3.00	1.410	0.273	0.170	× 6.1	781	76	35	6.9	4.3
× 3.5	1.03	3.00	1.372	0.273	0.132	× 5.2	665	76	35	6.9	3.4

⁴ Actual flange and web thicknesses vary due to mill rolling practices; however, permitted variations for such dimensions are not addressed.

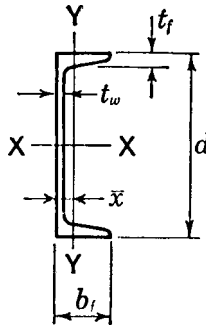
TABLE A2.6 "MC" Shapes

Designation (Nominal Depth in Inches and Weight in Pounds per Linear Foot)	Area A , in. ²	Depth d , in.	Flange		Web Thick- ness t_w , in. ^A	Designation [Nominal Depth in Millimetres and Mass in Kilo- grams per Metre]	Area A , mm ²	Depth d , mm	Flange		Web Thick- ness t_w , mm ^A
			Width b_f , in.	Thick- ness t_f , in. ^A					Width b_f , mm	Thick- ness t_f , mm ^A	
MC 18 × 58	17.1	18.00	4.200	0.625	0.700	MC 460 × 86	11 000	457	107	15.9	17.8
× 51.9	15.3	18.00	4.100	0.625	0.600	× 77.2	9 870	457	104	15.9	15.2
× 45.8	13.5	18.00	4.000	0.625	0.500	× 68.2	8 710	457	102	15.9	12.7
× 42.7	12.6	18.00	3.950	0.625	0.450	× 63.5	8 130	457	100	15.9	11.4
MC 13 × 50	14.7	13.00	4.412	0.610	0.787	MC 330 × 74	9 480	330	112	15.5	20.0
× 40	11.8	13.00	4.185	0.610	0.560	× 60	7 610	330	106	15.5	14.2
× 35	10.3	13.00	4.072	0.610	0.447	× 52	6 640	330	103	15.5	11.4
× 31.8	9.35	13.00	4.000	0.610	0.375	× 47.3	6 030	330	102	15.5	9.5
MC 12 × 50	14.7	12.00	4.135	0.700	0.835	MC 310 × 74	9 480	305	105	17.8	21.2
× 45	13.2	12.00	4.010	0.700	0.710	× 67	8 502	305	102	17.8	18.0
× 40	11.8	12.00	3.890	0.700	0.590	× 60	7 610	305	98	17.8	15.0
× 35	10.3	12.00	3.765	0.700	0.465	× 52	6 620	305	96	17.8	11.8
× 31	9.12	12.00	3.670	0.700	0.370	× 46	5 890	305	93	17.8	9.4
MC 12 × 14.3	4.19	12.00	2.125	0.313	0.250	MC 310 × 21.3	2 700	305	54	8.0	6.4
× 10.6	3.10	12.00	1.500	0.309	0.190	× 15.8	2 000	305	38	7.8	4.8
MC 10 × 41.1	12.1	10.00	4.321	0.575	0.796	MC 250 × 61.2	7 810	254	110	14.6	20.2
× 33.6	9.87	10.00	4.100	0.575	0.575	× 50	6 370	254	104	14.6	14.6
× 28.5	8.37	10.00	3.950	0.575	0.425	× 42.4	5 400	254	100	14.6	10.8
MC 10 × 25	7.35	10.00	3.405	0.575	0.380	MC 250 × 37	4 740	254	86	14.6	9.7
× 22	6.45	10.00	3.315	0.575	0.290	× 33	4 160	254	84	14.6	7.4
MC 10 × 8.4	2.46	10.00	1.500	0.280	0.170	MC 250 × 12.5	1 590	254	38	7.1	4.3
× 6.5	1.91	10.00	1.17	0.202	0.152	× 9.7	1 240	254	28	5.1	3.9
MC 9 × 25.4	7.47	9.00	3.500	0.550	0.450	MC 230 × 37.8	4 820	229	88	14.0	11.4
× 23.9	7.02	9.00	3.450	0.550	0.400	× 35.6	4 530	229	87	14.0	10.2
MC 8 × 22.8	6.70	8.00	3.502	0.525	0.427	MC 200 × 33.9	4 320	203	88	13.3	10.8
× 21.4	6.28	8.00	3.450	0.525	0.375	× 31.8	4 050	203	87	13.3	9.5
MC 8 × 20	5.88	8.00	3.025	0.500	0.400	MC 200 × 29.8	3 790	203	76	12.7	10.2
× 18.7	5.50	8.00	2.978	0.500	0.353	× 27.8	3 550	203	75	12.7	9.0
MC 8 × 8.5	2.50	8.00	1.874	0.311	0.179	MC 200 × 12.6	1 610	203	47	7.9	4.5
MC 7 × 22.7	6.67	7.00	3.603	0.500	0.503	MC 180 × 33.8	4 300	178	91	12.7	12.8
× 19.1	5.61	7.00	3.452	0.500	0.352	× 28.4	3 620	178	87	12.7	8.9
MC 6 × ×18	5.29	6.00	3.504	0.475	0.379	MC 150 × 26.8	3 410	152	88	12.1	9.6
× 15.3	4.50	6.00	3.500	0.385	0.340	× 22.8	2 900	152	88	9.8	8.6
MC 6 × 16.3	4.79	6.00	3.000	0.475	0.375	MC 150 × 24.3	3 090	152	76	12.1	9.5
× 15.1	4.44	6.00	2.941	0.475	0.316	× 22.5	2 860	152	74	12.1	8.0
MC 6 × 12	3.53	6.00	2.497	0.375	0.310	MC 150 × 17.9	2 280	152	63	9.5	7.9

TABLE A2.6 *Continued*

Designation (Nominal Depth in Inches and Weight in Pounds per Linear Foot)	Area A , in. ²	Depth d , in.	Flange		Web Thick- ness t_w , in. ^A	Designation [Nominal Depth in Millimetres and Mass in Kilo- grams per Metre]	Area A , mm ²	Depth d , mm	Flange		Web Thick- ness t_w , mm ^A
			Width b_f in.	Thick- ness t_f in. ^A					Width b_f mm	Thick- ness t_f , mm ^A	
MC 6 × 7.0 × 6.5	2.07	6.00	1.875	0.291	0.179	MC 150 × 10.4 × 9.7	1 341	152	48	7.4	4.5
	1.93	6.00	1.850	0.291	0.155		1 250	152	47	7.4	3.9
MC 4 × 13.8	4.02	4.00	2.500	0.500	0.500	MC 100 × 20.5	2 594	102	64	13	13
MC 3 × 7.1	2.09	3.00	1.938	0.351	0.312	MC 75 × 10.6	1 348	76	49	8.9	7.9

TABLE A2.7 “L” Shapes (Equal Legs)

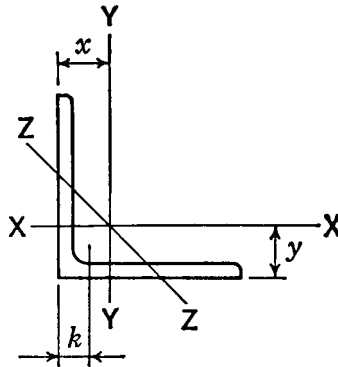

Size and Thickness, in.	Weight per Foot, lb	Area, in. ²	Size and Thickness, mm	Mass per Metre, kg	Area, mm ²
L8 × 8 × 1 ¹ / ₈	56.9	16.7	L203 × 203 × 28.6	84.7	10 800
L8 × 8 × 1	51.0	15.0	L203 × 203 × 25.4	75.9	9 680
L8 × 8 × 7 ¹ / ₈	45.0	13.2	L203 × 203 × 22.2	67.0	8 500
L8 × 8 × 3 ¹ / ₄	38.9	11.4	L203 × 203 × 19.0	57.9	7 360
L8 × 8 × 5 ¹ / ₈	32.7	9.61	L203 × 203 × 15.9	48.7	6 200
L8 × 8 × 9 ¹ / ₁₆	29.6	8.68	L203 × 203 × 14.3	44.0	5 600
L8 × 8 × 1 ¹ / ₂	26.4	7.75	L203 × 203 × 12.7	39.3	5 000
L6 × 6 × 1	37.4	11.0	L152 × 152 × 25.4	55.7	7 100
L6 × 6 × 7 ¹ / ₈	33.1	9.73	L152 × 152 × 22.2	49.3	6 280
L6 × 6 × 3 ¹ / ₄	28.7	8.44	L152 × 152 × 19.0	42.7	5 450
L6 × 6 × 5 ¹ / ₈	24.2	7.11	L152 × 152 × 15.9	36.0	4 590
L6 × 6 × 9 ¹ / ₁₆	21.9	6.43	L152 × 152 × 14.3	32.6	4 150
L6 × 6 × 1 ¹ / ₂	19.6	5.75	L152 × 152 × 12.7	29.2	3 710
L6 × 6 × 7 ¹ / ₁₆	17.2	5.06	L152 × 152 × 11.1	25.6	3 270
L6 × 6 × 3 ¹ / ₈	14.9	4.36	L152 × 152 × 9.5	22.2	2 810
L6 × 6 × 5 ¹ / ₁₆	12.4	3.65	L152 × 152 × 7.9	18.5	2 360
L5 × 5 × 7 ¹ / ₈	27.2	7.98	L127 × 127 × 22.2	40.5	5 150
L5 × 5 × 3 ¹ / ₄	23.6	6.94	L127 × 127 × 19.0	35.1	4 480
L5 × 5 × 5 ¹ / ₈	20.0	5.86	L127 × 127 × 15.9	29.8	3 780
L5 × 5 × 1 ¹ / ₂	16.2	4.75	L127 × 127 × 12.7	24.1	3 070
L5 × 5 × 7 ¹ / ₁₆	14.3	4.18	L127 × 127 × 11.1	21.3	2 700
L5 × 5 × 3 ¹ / ₈	12.3	3.61	L127 × 127 × 9.5	18.3	2 330
L5 × 5 × 5 ¹ / ₁₆	10.3	3.03	L127 × 127 × 7.9	15.3	1 960
L4 × 4 × 3 ¹ / ₄	18.5	5.44	L102 × 102 × 19.0	27.5	3 510
L4 × 4 × 5 ¹ / ₈	15.7	4.61	L102 × 102 × 15.9	23.4	2 970
L4 × 4 × 1 ¹ / ₂	12.8	3.75	L102 × 102 × 12.7	19.0	2 420
L4 × 4 × 7 ¹ / ₁₆	11.3	3.31	L102 × 102 × 11.1	16.8	2 140
L4 × 4 × 3 ¹ / ₈	9.80	2.86	L102 × 102 × 9.5	14.6	1 850
L4 × 4 × 5 ¹ / ₁₆	8.20	2.40	L102 × 102 × 7.9	12.2	1 550
L4 × 4 × 1 ¹ / ₄	6.60	1.94	L102 × 102 × 6.4	9.8	1 250
L3 ¹ / ₂ × 3 ¹ / ₂ × 1 ¹ / ₂	11.1	3.25	L89 × 89 × 12.7	16.5	2 100
L3 ¹ / ₂ × 3 ¹ / ₂ × 7 ¹ / ₁₆	9.80	2.87	L89 × 89 × 11.1	14.6	1 850
L3 ¹ / ₂ × 3 ¹ / ₂ × 3 ¹ / ₈	8.50	2.48	L89 × 89 × 9.5	12.6	1 600
L3 ¹ / ₂ × 3 ¹ / ₂ × 5 ¹ / ₁₆	7.20	2.09	L89 × 89 × 7.9	10.7	1 350
L3 ¹ / ₂ × 3 ¹ / ₂ × 1 ¹ / ₄	5.80	1.69	L89 × 89 × 6.4	8.6	1 090
L3 × 3 × 1 ¹ / ₂	9.40	2.75	L76 × 76 × 12.7	14.0	1 770
L3 × 3 × 7 ¹ / ₁₆	8.30	2.43	L76 × 76 × 11.1	12.4	1 570
L3 × 3 × 3 ¹ / ₈	7.20	2.11	L76 × 76 × 9.5	10.7	1 360
L3 × 3 × 5 ¹ / ₁₆	6.10	1.78	L76 × 76 × 7.9	9.1	1 150
L3 × 3 × 1 ¹ / ₄	4.90	1.44	L76 × 76 × 6.4	7.3	929
L3 × 3 × 3 ¹ / ₁₆	3.71	1.09	L76 × 76 × 4.8	5.5	703
L2 ¹ / ₂ × 2 ¹ / ₂ × 1 ¹ / ₂	7.70	2.25	L64 × 64 × 12.7	11.4	1 450
L2 ¹ / ₂ × 2 ¹ / ₂ × 3 ¹ / ₈	5.90	1.73	L64 × 64 × 9.5	8.7	1 120
L2 ¹ / ₂ × 2 ¹ / ₂ × 5 ¹ / ₁₆	5.00	1.46	L64 × 64 × 7.9	7.4	942
L2 ¹ / ₂ × 2 ¹ / ₂ × 1 ¹ / ₄	4.10	1.19	L64 × 64 × 6.4	6.1	768
L2 ¹ / ₂ × 2 ¹ / ₂ × 3 ¹ / ₁₆	3.07	0.90	L64 × 64 × 4.8	4.6	581
L2 × 2 × 3 ¹ / ₈	4.70	1.36	L51 × 51 × 9.5	7.0	877

TABLE A2.7 *Continued*

Size and Thickness, in.	Weight per Foot, lb	Area, in. ²	Size and Thickness, mm	Mass per Metre, kg	Area, mm ²
L2 × 2 × 5/16	3.92	1.15	L51 × 51 × 7.9	5.8	742
L2 × 2 × 1/4	3.19	0.938	L51 × 51 × 6.4	4.7	605
L2 × 2 × 3/16	2.44	0.715	L51 × 51 × 4.8	3.6	461
L2 × 2 × 1/8	1.65	0.484	L51 × 51 × 3.2	2.4	312
L1 3/4 × 1 3/4 × 1/4	2.77	0.813	L44 × 44 × 6.4	4.1	525
L1 3/4 × 1 3/4 × 3/16	2.12	0.621	L44 × 44 × 4.8	3.1	401
L1 3/4 × 1 3/4 × 1/8	1.44	0.422	L44 × 44 × 3.2	2.1	272
L1 1/2 × 1 1/2 × 1/4	2.34	0.688	L38 × 38 × 6.4	3.4	444
L1 1/2 × 1 1/2 × 3/16	1.80	0.527	L38 × 38 × 4.8	2.7	340
L1 1/2 × 1 1/2 × 5/32	1.52	0.444	L38 × 38 × 4.0	2.2	286
L1 1/2 × 1 1/2 × 1/8	1.23	0.359	L38 × 38 × 3.2	1.8	232
L1 1/4 × 1 1/4 × 1/4	1.92	0.563	L32 × 32 × 6.4	2.8	363
L1 1/4 × 1 1/4 × 3/16	1.48	0.434	L32 × 32 × 4.8	2.2	280
L1 1/4 × 1 1/4 × 1/8	1.01	0.297	L32 × 32 × 3.2	1.5	192
L1 × 1 × 1/4	1.49	0.438	L25 × 25 × 6.4	2.2	283
L1 × 1 × 3/16	1.16	0.340	L25 × 25 × 4.8	1.8	219
L1 × 1 × 1/8	0.80	0.234	L25 × 25 × 3.2	1.2	151
L3/4 × 3/4 × 1/8	0.59	0.172	L19 × 19 × 3.2	0.9	111

TABLE A2.8 "L" Shapes (Unequal Legs)

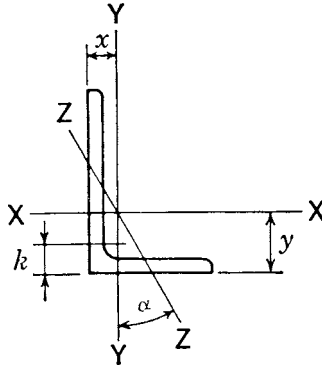

Size and Thickness, in.	Weight per Foot, lb	Area, in. ²	Size and Thickness, mm	Mass per Metre, kg	Area, mm ²
L8 × 6 × 1	44.2	13.0	L203 × 152 × 25.4	65.5	8 390
L8 × 6 × 7/8	39.1	11.5	L203 × 152 × 22.2	57.9	7 420
L8 × 6 × 3/4	33.8	9.94	L203 × 152 × 19.0	50.1	6 410
L8 × 6 × 5/8	28.5	8.36	L203 × 152 × 15.9	42.2	5 390
L8 × 6 × 9/16	25.7	7.56	L203 × 152 × 14.3	38.1	4 880
L8 × 6 × 1/2	23.0	6.75	L203 × 152 × 12.7	34.1	4 350
L8 × 6 × 7/16	20.2	5.93	L203 × 152 × 11.1	29.9	3 830
L8 × 4 × 1	37.4	11.0	L203 × 102 × 25.4	55.4	7 100
L8 × 4 × 7/8	33.1	9.73	L203 × 102 × 22.2	49.3	6 280
L8 × 4 × 3/4	28.7	8.44	L203 × 102 × 19.0	42.5	5 450
L8 × 4 × 5/8	24.2	7.11	L203 × 102 × 15.9	36.0	4 590
L8 × 4 × 9/16	21.9	6.43	L203 × 102 × 14.3	32.4	4 150
L8 × 4 × 1/2	19.6	5.75	L203 × 102 × 12.7	29.0	3 710
L8 × 4 × 7/16	17.2	5.06	L203 × 102 × 11.1	25.6	3 260
L7 × 4 × 3/4	26.2	7.69	L178 × 102 × 19.0	38.8	4 960
L7 × 4 × 5/8	22.1	6.48	L178 × 102 × 15.9	32.7	4 180
L7 × 4 × 1/2	17.9	5.25	L178 × 102 × 12.7	26.5	3 390
L7 × 4 × 7/16	15.7	4.62	L178 × 102 × 11.1	23.4	2 980
L7 × 4 × 3/8	13.6	3.98	L178 × 102 × 9.5	20.2	2 570
L6 × 4 × 7/8	27.2	7.98	L152 × 102 × 22.2	40.3	5 150
L6 × 4 × 3/4	23.6	6.94	L152 × 102 × 19.0	35.0	4 480
L6 × 4 × 5/8	20.0	5.86	L152 × 102 × 15.9	29.6	3 780
L6 × 4 × 9/16	18.1	5.31	L152 × 102 × 14.3	26.8	3 430
L6 × 4 × 1/2	16.2	4.75	L152 × 102 × 12.7	24.0	3 060
L6 × 4 × 7/16	14.3	4.18	L152 × 102 × 11.1	21.2	2 700
L6 × 4 × 3/8	12.3	3.61	L152 × 102 × 9.5	18.2	2 330
L6 × 4 × 5/16	10.3	3.03	L152 × 102 × 7.9	15.3	1 950
L6 × 3 1/2 × 1/2	15.3	4.50	L152 × 89 × 12.7	22.7	2 900
L6 × 3 1/2 × 3/8	11.7	3.42	L152 × 89 × 9.5	17.3	2 210
L6 × 3 1/2 × 5/16	9.80	2.87	L152 × 89 × 7.9	14.5	1 850
L5 × 3 1/2 × 3/4	19.8	5.81	L127 × 89 × 19.0	29.3	3 750
L5 × 3 1/2 × 5/8	16.8	4.92	L127 × 89 × 15.9	24.9	3 170
L5 × 3 1/2 × 1/2	13.6	4.00	L127 × 89 × 12.7	20.2	2 580
L5 × 3 1/2 × 3/8	10.4	3.05	L127 × 89 × 9.5	15.4	1 970
L5 × 3 1/2 × 5/16	8.70	2.56	L127 × 89 × 7.9	12.9	1 650
L5 × 3 1/2 × 1/4	7.00	2.06	L127 × 89 × 6.4	10.4	1 330
L5 × 3 × 1/2	12.8	3.75	L127 × 76 × 12.7	19.0	2 420
L5 × 3 × 7/16	11.3	3.31	L127 × 76 × 11.1	16.7	2 140
L5 × 3 × 3/8	9.80	2.86	L127 × 76 × 9.5	14.5	1 850
L5 × 3 × 5/16	8.20	2.40	L127 × 76 × 7.9	12.1	1 550
L5 × 3 × 1/4	6.60	1.94	L127 × 76 × 6.4	9.8	1 250
L4 × 3 1/2 × 1/2	11.9	3.50	L102 × 89 × 12.7	17.6	2 260
L4 × 3 1/2 × 3/8	9.10	2.67	L102 × 89 × 9.5	13.5	1 720
L4 × 3 1/2 × 5/16	7.70	2.25	L102 × 89 × 7.9	11.4	1 450
L4 × 3 1/2 × 1/4	6.20	1.81	L102 × 89 × 6.4	9.2	1 170
L4 × 3 × 5/8	13.6	3.98	L102 × 76 × 15.9	20.2	2 570

TABLE A2.8 *Continued*

Size and Thickness, in.	Weight per Foot, lb	Area, in. ²	Size and Thickness, mm	Mass per Metre, kg	Area, mm ²
L4 × 3 × 1/2	11.1	3.25	L102 × 76 × 12.7	16.4	2 100
L4 × 3 × 3/8	8.50	2.48	L102 × 76 × 9.5	12.6	1 600
L4 × 3 × 5/16	7.20	2.09	L102 × 76 × 7.9	10.7	1 350
L4 × 3 × 1/4	5.80	1.69	L102 × 76 × 6.4	8.6	1 090
L3 1/2 × 3 × 1/2	10.2	3.00	L89 × 76 × 12.7	15.1	1 940
L3 1/2 × 3 × 7/16	9.10	2.65	L89 × 76 × 11.1	13.5	1 710
L3 1/2 × 3 × 3/8	7.90	2.30	L89 × 76 × 9.5	11.7	1 480
L3 1/2 × 3 × 5/16	6.60	1.93	L89 × 76 × 7.9	9.8	1 250
L3 1/2 × 3 × 1/4	5.40	1.56	L89 × 76 × 6.4	8.0	1 010
L3 1/2 × 2 1/2 × 1/2	9.40	2.75	L89 × 64 × 12.7	13.9	1 770
L3 1/2 × 2 1/2 × 3/8	7.20	2.11	L89 × 64 × 9.5	10.7	1 360
L3 1/2 × 2 1/2 × 5/16	6.10	1.78	L89 × 64 × 7.9	9.0	1 150
L3 1/2 × 2 1/2 × 1/4	4.90	1.44	L89 × 64 × 6.4	7.3	929
L3 × 2 1/2 × 1/2	8.50	2.50	L76 × 64 × 12.7	12.6	1 610
L3 × 2 1/2 × 7/16	7.60	2.21	L76 × 64 × 11.1	11.3	1 430
L3 × 2 1/2 × 3/8	6.60	1.92	L76 × 64 × 9.5	9.8	1 240
L3 × 2 1/2 × 5/16	5.60	1.62	L76 × 64 × 7.9	8.3	1 050
L3 × 2 1/2 × 1/4	4.50	1.31	L76 × 64 × 6.4	6.7	845
L3 × 2 1/2 × 3/16	3.39	0.996	L76 × 64 × 4.8	5.1	643
L3 × 2 × 1/2	7.70	2.25	L76 × 51 × 12.7	11.5	1 450
L3 × 2 × 3/8	5.90	1.73	L76 × 51 × 9.5	8.8	1 120
L3 × 2 × 5/16	5.00	1.46	L76 × 51 × 7.9	7.4	942
L3 × 2 × 1/4	4.10	1.19	L76 × 51 × 6.4	6.1	768
L3 × 2 × 3/16	3.07	0.902	L76 × 51 × 4.8	4.6	582
L2 1/2 × 2 × 3/8	5.30	1.55	L64 × 51 × 9.5	7.9	1 000
L2 1/2 × 2 × 5/16	4.50	1.31	L64 × 51 × 7.9	6.7	845
L2 1/2 × 2 × 1/4	3.62	1.06	L64 × 51 × 6.4	5.4	684
L2 1/2 × 2 × 3/16	2.75	0.809	L64 × 51 × 4.8	4.2	522
L2 1/2 × 1 1/2 × 1/4	3.19	0.938	L64 × 38 × 6.4	4.8	605
L2 1/2 × 1 1/2 × 3/16	2.44	0.715	L64 × 38 × 4.8	3.6	461
L2 × 1 1/2 × 1/4	2.77	0.813	L51 × 38 × 6.4	4.2	525
L2 × 1 1/2 × 3/16	2.12	0.621	L51 × 38 × 4.8	3.1	401
L2 × 1 1/2 × 1/8	1.44	0.422	L51 × 38 × 3.2	2.1	272

APPENDIXES

(Nonmandatory Information)

X1. COIL AS A SOURCE OF STRUCTURAL PRODUCTS

X1.1 Continuous wide hot strip rolling mills are normally equipped with coilers. Regardless of the different types of systems employed during or following the rolling operations, it is common for the steel to be reeled into the coiler at temperatures in the stress-relieving range. In general, such temperatures are higher as the steel thickness increases. The coils subsequently cool to ambient temperature with outer and inner laps cooling more rapidly than central laps. The differ-

ence in cooling rate can result in measurable differences in the mechanical properties throughout a coil. Data confirm reduced yield and tensile strength with increased percent elongation for the steel with slower cooling rates from the coiling temperature to ambient. Such differences are in addition to the effects on mechanical properties caused by differences in heat analysis and chemical segregation.

X2. VARIATION OF TENSILE PROPERTIES IN PLATES AND SHAPES

X2.1 The tension testing requirements of this specification are intended only to characterize the tensile properties of a heat of steel for determination of conformance to the requirements of the applicable product specification. Such testing procedures are not intended to define the upper or lower limits of tensile properties at all possible test locations within a heat of steel. It is well known and documented that tensile properties will vary within a heat or individual piece of steel as a function of chemical composition, processing, testing procedure and other factors. It is, therefore, incumbent on designers and engineers to use sound engineering judgement when using tension test results shown on mill test reports. The testing procedures of this specification have been found to provide structural products adequate for normal structural design criteria.

X2.2 A survey of the variation to be expected in tensile properties obtained from plates and structural shapes was conducted by the American Iron and Steel Institute (AISI).⁸ The results of this survey are contained in a *Contributions to the Metallurgy of Steel* entitled “The Variation of Product Analysis and Tensile Properties—Carbon Steel Plates and Wide Flange Shapes” (SU/18, SU/19 and SU/20), published in September 1974. The data are presented in tables of probability that tensile properties at other than the official location may differ from those of the reported test location. Another survey sponsored by the AISI entitled “Statistical Analysis of Structural Plate Mechanical Properties” was published in January

2003. That survey analyzed the results of variability testing on more modern as-rolled steels that were generally of higher minimum yield strength steels and also compared those results statistically to the previous surveys.⁹

X2.3 This specification contains no requirements applicable to product tension tests; conformance to the applicable product specification is determined on the basis of tests performed at the place of manufacture or processing prior to shipment, unless otherwise specified.

X2.4 A task group of ASTM Subcommittee A01.02 has determined, based on review of the earlier AISI data,⁸ that the variation in tensile properties of plates and structural shapes can be expressed as a function of specified requirements: one standard deviation equals approximately 4 % of required tensile strength, 8 % of required yield strength, and 3 percentage points of required elongation. The January 2003 survey resulted in similar findings.

X2.5 Acceptance criteria for product testing based upon these values, either below the minimum or above the maximum allowed by the applicable product specification, are generally acceptable to manufacturers. Such tolerances could be considered by users of structural products as a reasonable basis for acceptance of structural products that, due to their inherent variability, deviate from the applicable product specification requirements when subjected to product tension testing.

⁸ Originally published by the American Iron and Steel Institute (AISI), 1140 Connecticut Ave., NW, Suite 705, Washington, DC 20036, <http://www.steel.org>. Available from ASTM Headquarters as PCN: 29-000390-02.

⁹ Available from American Iron and Steel Institute (AISI) directly at <http://www.steel.org/infrastructure/bridges/index.html>.

X3. WELDABILITY OF STEEL

X3.1 *Weldability* is a term that usually refers to the relative ease with which a metal can be welded using conventional practice. Difficulties arise in steel when the cooling rates associated with weld thermal cycles produce microstructures (for example, martensite) that are susceptible to brittle fracture or, more commonly, hydrogen-induced (or cold) cracking.¹⁰ (Solidification or hot cracking is a relatively rare phenomenon that will not be addressed here. See Randall¹¹ for further information.)

X3.2 The relative sensitivity of steels to forming cold cracking microstructures is called hardenability and can be measured in a number of ways. Perhaps the most popular method of assessing this is by the carbon equivalent (CE) formula, which attempts to equate the relative hardening contributions of a steel's constituent elements (for example, manganese, vanadium) to an equivalent amount of carbon, which is the most significant hardening agent. The most popular formula is the International Institute of Welding (IIW) equation presented in S31.2, which has been found suitable for predicting hardenability in a wide range of commonly used carbon-manganese and low alloy steels.¹²

X3.3 It should be noted, however, that for the current generation of low carbon (<0.10 %) low alloy steels that derive strength from a combination of microalloys and thermal

processing methods the use of other formulae may more accurately assess hardenability and cold cracking sensitivity.¹³

X3.4 For a vast number of common structural applications it is unnecessary to specify the use of CE limits. However, in order to obtain a higher level of confidence in avoiding cold cracking, the chemistry controls in S31 are available. A purchaser who specifies the use of S31 should be aware that there are several factors involved in the judicious selection of a maximum CE value, such as the following:

- X3.4.1 Actual production joint restraint/base metal thickness(es),
- X3.4.2 Filler metal and base metal strength compatibility,
- X3.4.3 Deposited weld metal diffusible hydrogen content,
- X3.4.4 Preheat and interpass temperatures,
- X3.4.5 Filler metal and base metal cleanliness, and
- X3.4.6 Heat input.

X3.5 Though it is widely believed that low CE steels are immune to weld cracking problems, failure to consider these factors and others have resulted in weld or base metal HAZ (heat affected zone) cracks in such steels.¹¹

X3.6 It is important to note that carbon equivalence is only a qualitative assessment of potential welding problems, and should never be solely relied on to ensure weld integrity. The proper use of welding specifications, coupled with the knowledge of actual construction conditions, must also be used.

¹⁰ Graville, B. A., *The Principles of Cold Cracking Control in Welds*, Dominion Bridge Company, 1975.

¹¹ Randall, M. D., "Welding Procedure Factors Affecting Weldability for Service," *Weldability of Steels*, by Stout and Doty, Welding Research Council.

¹² Bailey, N., "The Development and Use of Carbon Equivalent in Britain," *Hardenability of Steels*, Abington Publishing, 1990.

¹³ International Institute of Welding, "Guide to the Metallurgy of Welding and Weldability of Low Carbon Microalloyed Hot Rolled Steels," Document IIS/IIW-843-87.

X4. RADIUS FOR COLD BENDING

X4.1 Suggested minimum inside bend radii for cold forming are referenced to Group Designations A to F inclusive as defined in **Table X4.1**. The suggested radii listed in **Table X4.2** should be used as minimums in typical shop fabrication. Material that does not form satisfactorily when fabricated in accordance with **Table X4.2** may be subject to rejection pending negotiation with the steel supplier. When tighter bends are required, the manufacturer should be consulted.

X4.2 The bend radius and the radius of the male die should be as liberal as the finished part will permit. The width across the shoulders of the female die should be at least eight times the plate thickness. Higher strength steels require larger die openings. The surface of the dies in the area of radius should be smooth.

X4.2.1 Since cracks in cold bending commonly originate from the outside edges, shear burrs and gas cut edges should be removed by grinding. Sharp corners on edges and on punched or gas cut holes should be removed by chamfering or grinding to a radius.

X4.2.2 If possible, parts should be formed such that the bend line is perpendicular to the direction of final rolling. If it is necessary to bend with the bend line parallel to the direction of final rolling, a more generous radius is suggested (1½ times applicable value given in **Table X4.2** for bend lines perpendicular to the direction of rolling).

TABLE X4.1 Group Designations for Cold Bending

Specification	Grade	Group Designation ^A
A36/A36M	^B	B
A131/A131M	A, B, D, CS and E A, B, D, CS and E (all cold flanging) AH32, DH32, EH32 and FH 32 AH36, DH36, EH36 and FH36 AH40, DH40, EH40 and FH40	B B C C C
A242/A242M	^B	C
A283/A283M	A or B C or D	A B
A514/A514M	any	F
A529/A529M	50 [345] or 55 [380]	C
A572/A572M	42 [290] 50 [345] 55 [380] 60 [415] or 65 [450]	B C D E
A573/A573M	58 [400] or 65 [450] 70 [485]	B C
A588/A588M	any	C
A633/A633M	any	B
A656/A656M	50 [345] 60 [415] 70 [485] 80 [550]	B D E F
A678/A678M	A or B C or D	C D
A709/A709M	36 [250] 50 [345], 50W [345W] or HPS 50W [HPS 345W] HPS70W [HPS485W] HPS 100W [HPS 690W]	B C D F
A710/A710M	A	F
A808/A808M	^B	C
A852/A852M	^B	D
A871/A871M	60 [415] or 65 [450]	E
A945/A945M	50 [345] or 65 [450]	B

^A Steels having a ratio of specified minimum tensile strength to specified minimum yield strength of 1.15 or less are in Group F; other steels are in Groups A to E inclusive, which are grouped on the basis of their having similar specified values for minimum elongation in 2 in. [50 mm].

^B Grade designations are not applicable for this specification.

TABLE X4.2 Suggested Minimum Inside Radii for Cold Bending^A

Group Designation ^B	Thickness (t), in. [mm]			
	Up to ¼ in. [20 mm]	Over ¼ in. [20 mm] To 1 [25 mm, incl]	Over 1 in. [25 mm] To 2 in. [50 mm], incl	Over 2 in. [50 mm]
A	1.5t	1.5t	1.5t	1.5t
B	1.5t	1.5t	1.5t	2.0t
C	1.5t	1.5t	2.0t	2.5t
D	1.5t	1.5t	2.5t	3.0t
E	1.5t	1.5t	3.0t	3.5t
F	1.75t	2.25t	4.5t	5.5t

^A Values are for bend lines perpendicular to the direction of final rolling. These radii apply when the precautions listed in X4.2 are followed. If bend lines are parallel to the direction of final rolling, multiply values by 1.5.

^B Steel specifications included in the group designations may not include the entire thickness range shown in this table.

X4.3 References

X4.3.1 Holt, G. E., et al, “Minimum Cold Bend Radii Project—Final Report,” Concurrent Technologies Corporation, January 27, 1997.¹⁴

X4.3.2 Brockenbrough, R. L., “Fabrication Guidelines for Cold Bending,” R. L. Brockenbrough & Associates, June 28, 1998.¹⁴

¹⁴ Available from American Iron and Steel Institute (AISI), 1140 Connecticut Ave., NW, Suite 705, Washington, DC 20036, <http://www.steel.org>.

SUMMARY OF CHANGES

Committee A01 has identified the location of selected changes to this standard since the last issue (A6/A6M – 10) that may impact the use of this standard. (Approved Oct. 1, 2010.)

(I) Revised **Table A2.2**, **Table A2.3**, **Table A2.4**, **Table A2.5**, **Table A2.6**, **Table A2.7**, and **Table A2.8**.

Committee A01 has identified the location of selected changes to this standard since the last issue (A6/A6M – 09) that may impact the use of this standard. (Approved April 1, 2010.)

(I) Revised **Table 24**, **Table A1.24**, and **Table A2.4** to include nominal dimensions of HP16 and HP18 sections.

Committee A01 has identified the location of the following changes to this standard since the last issue (A6/A6M – 08a) that may impact the use of this standard. (Approved April 1, 2009.)

(I) Revised **Table X4.1**.

ASTM International takes no position respecting the validity of any patent rights asserted in connection with any item mentioned in this standard. Users of this standard are expressly advised that determination of the validity of any such patent rights, and the risk of infringement of such rights, are entirely their own responsibility.

This standard is subject to revision at any time by the responsible technical committee and must be reviewed every five years and if not revised, either reapproved or withdrawn. Your comments are invited either for revision of this standard or for additional standards and should be addressed to ASTM International Headquarters. Your comments will receive careful consideration at a meeting of the responsible technical committee, which you may attend. If you feel that your comments have not received a fair hearing you should make your views known to the ASTM Committee on Standards, at the address shown below.

This standard is copyrighted by ASTM International, 100 Barr Harbor Drive, PO Box C700, West Conshohocken, PA 19428-2959, United States. Individual reprints (single or multiple copies) of this standard may be obtained by contacting ASTM at the above address or at 610-832-9585 (phone), 610-832-9555 (fax), or service@astm.org (e-mail); or through the ASTM website (www.astm.org). Permission rights to photocopy the standard may also be secured from the ASTM website (www.astm.org/COPYRIGHT/).